

# NAUTILUS

PORTABLE EXTRACTOR



## Nautilus MX200 Operating Manual

**HF HYDRO-FORCE™**  
Innovating since 1974

#LMANN06 Revised: 01-29-2015

Nautilus MX200 Operating Manual  
**TABLE OF CONTENTS**

<u>TOPIC</u>	<u>PAGE #</u>
• Introduction	3
• Technical Specifications	4
• Optional Equipment	5
<b><u>SECTION 1: Operational Safety</u></b>	
• Electrical Safety	6
• Mechanical Safety	7
<b><u>SECTION 2: Operation Procedures</u></b>	
• Vacuum Connections	8
• Electrical Supply	9
• Water Supply & Chemicals	10
• Solution Hose & Pump Priming	13
• Heater & Vacuum Hose	14
• Foam Downer	15
• Pump-Out System	16
• Shutdown Procedures	17
• Accessory Storage	18
• Troubleshooting	19
• Solution Flow Path	22
• Wiring Diagrams	23
<b><u>SECTION 3: Maintenance/ Technical</u></b>	
• Maintenance	27
• Drawings & Parts Lists	
○ Pump	35
○ Pressure Unloader	36
○ Auto-Fill	37
○ Pump-Out Pump	39
○ Parts Pictures	40
○ Parts List	51
○ Hose List	54
• Warranty	55

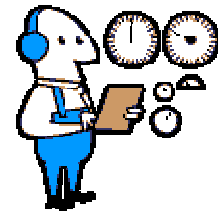

# Introduction

Congratulations on your purchase of the Hydro-Force Nautilus MX200. The MX200 is designed to give truck mount-level performance in a portable machine that combines versatility with ease of transport. Years of experience, engineering, and planning have gone into the design and manufacturing of the MX200. We take a great deal of pride in the MX200; our goal is no less than your complete satisfaction.

**The Hydro-Force Nautilus MX200 is intended for commercial use only.**

This manual will provide users with the knowledge required to operate the Nautilus MX200 safely, to understand how to properly operate and maintain the machine, and to ensure that the equipment operates at its maximum performance level.



**All users must read and understand this manual completely before operating the machine.**

Always maintain this manual in legible condition adjacent to the Nautilus MX200, or place in a secure location for future reference.

Any questions pertaining to the operating or servicing of this unit should be directed to your nearest Hydro-Force distributor.

This manual is written specifically for the Nautilus MX200 portable extractor units manufactured by:

Hydro-Force  
4282 South 590 West  
Salt Lake City, UT 84123  
801-268-2673  
801-268-3856 FAX

Information in this manual is subject to change without notice and does not represent a commitment on the part of Hydro-Force or its parent or affiliated companies.

# Technical Specifications

## MX200 High Pressure Extractor

Height: 42-1/4"

Length: 34-3/8"

Width: 23-3/8"

Weight: 112 lbs.

Solution Tank Capacity: 12 gallon

Recovery Tank Capacity: 12 gallon

Solution Pump: Pump-Tec #114 pump with 1.4amp Motor  
0-200 psi – 0.89 gpm

Vacuum Motors: Two AMETEK Lamb 5.7" diameter 2-Stage – tangential discharge  
Can be operated in series or parallel configuration

Pump-out Pump: FloJet 120VAC 4.5 gpm  
(Optional)

Power Draw: Cord #1 – 18.75 Amp wide open / 11.73amp full load  
(Add 1.50amps to Cord #1 for non-heated units with optional Pump-Out Pump)  
Optional Cord #2 – 14.58 amps for units with optional 1750W Heater  
(Add 1.50amps to Cord #2 for heated units with optional Pump-Out Pump)

## Standard Equipment

Vacuum Connection: 2" Barb or 2" Male Flash Cuff with 2" Male NPT

Vacuum Hose: 25' X 1-1/2" with 1-1/2" cuff & 2" cuff  
2" Female Flash Cuff x 1-1/2" hose adapter

Carpet Wand: 1-1/2" SS Dual Jet S-Bend Wand – AW29

Accessory Mount Hardware: Four 1/4-20 x 5/8" SS Screws & Washers

HP Solution Hose: 25' x 1/4" with 1/4" male & female quick connects

Power Cords: 1 – 25' x 12gauge with male & female plug ends

Electrical: 5amp Pump Circuit Breaker  
Internal Component Cooling Fan

## Optional Features:

1750W Heater:

Dual Circuit Indicator:

Auto Fill System with chemical draw:

Metering Tip Kit: 14 different tips for changing chemical dilution rate

Water Supply Hose: 50' x 3/8" with 1/4" female quick connect &  
Female garden hose fitting

Auto Pump-out System:

Pump-out Hose: 50' x 3/4" with male & female garden hose fittings



**Additional / Optional Equipment**

Wand Glide – Delrin

Wand Glide – Teflon

18” Bottom Velcro Strap for Wand Holder

Hy-Dry Deluxe Upholstery Tool:

1-1/2” Vacuum Hose: (Sold per foot – No cuffs)

2” cuff for 1-1/2” Vac Hose:

1-1/2” cuff for 1-1/2” Vac Hose:

1-1/2” Hose Connector PVC:

HP Solution Hose 1/4” X 25’ w/M-F Quick Connects

1/4” Male Quick Connect:

1/4” Female Quick Connect:

Pump-out Hose:

Hydro Filter II:

Replacement Screen for Hydro-Filter II:

Metering Tip Kit:

12/3 X 25’ Power Cord:

12/3 X 50’ GFCI Power Cord:

Belt Pack

AW529D

AW529T

NM5841

AW50D

AH36

AH46

AH42

AH74

AH79D

AH102B

AH101B

AH65

AC10

AC10C

PDE001

AX32

NM4407A

AX108

**AC10**



**AC10C**

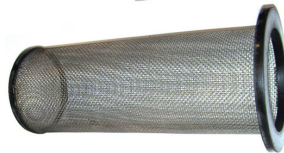

**AX108**



**NM4407A**



**AX32**



**AW50D**

## Safety

### **⚠️ WARNING**

**This machine is an electrical appliance.**

**Care must be taken to reduce the risk of electrical shock.**

**READ AND UNDERSTAND ALL INSTRUCTIONS BEFORE OPERATING THE MX200.**

- To reduce the risk of property damage or injury, repairs to electrical systems should only be performed by experienced technicians. Contact your distributor for assistance. Unplug machine power cord from outlet before performing any repairs on the extractor.
- This machine shall be grounded while in use to protect the operator from electric shock. The machine is provided with a three-conductor cord and a three-contact grounding type attachment plug to fit the proper grounding type receptacle. The green (or green and yellow) conductor in the cord is the grounding wire. Never connect this wire to other than the grounding pin of the attachment plug.
- This machine is for use on a nominal 120-volt circuit and has a grounding plug that resembles the plug illustrated in the sketch to the right. Make sure that the machine is connected to an outlet having the same configuration as the plug. No plug adapter should be used with this machine.
- The power cord supplied with this machine is properly sized to handle the electrical load of this machine and properly grounded as described above. Any extension cords used with this machine must be similarly sized with an equal or greater load rating and grounded to assure safe operation. A properly sized or rated GFCI protected cord can be used for additional protection.
- Do not use the MX200 outdoors, in standing water or on wet surfaces. Do not store the MX200 in wet conditions. If extractor is leaking, unplug machine power cords from outlets before approaching or touching machine.
- Do not unplug power cord by pulling on the cord. Grasp the plug end when unplugging the cord. Do not pull the extractor by the cord. If cord or plug is damaged, do not use cord. Replace with new cord or repair as needed before use.
- Overloaded circuit may not always trip circuit breaker. Reduced voltage to a machine on an overloaded circuit will prevent components from operating properly.

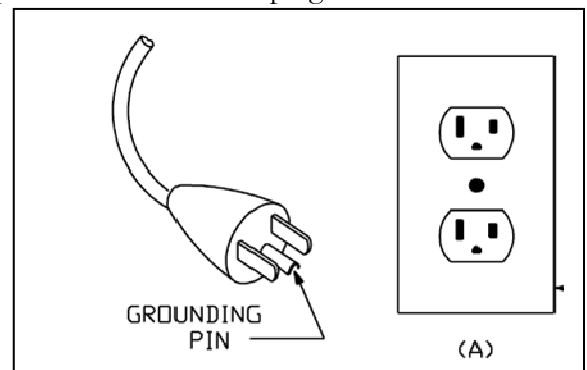

# NOTICE

**This machine must be protected from conditions which may damage the pump, tank, hoses and other components.**

- **Freezing of water in this machine will cause serious damage.** The MX200, solution hoses, and tools must be protected from freezing temperature. Store, transport, and use this equipment only in temperatures well above freezing. (32°F or 0°C). If you suspect the MX200 has been frozen, do not plug in or turn on machine until you are sure it has thawed completely.
- If the equipment cannot be stored or transported in a warm environment, it can be guarded from freezing by running an anti-freeze solution through the incoming water lines, chemical feed system, solution pump, solution lines, tools and pump-out pump. The machine is filled at the factory with anti-freeze to eliminate damage during shipment in cold weather.
  - The anti-freeze solution must be completely flushed from the machine before it is returned to service.
- The MX200 must not be used to pick up flammable or combustible materials or used in areas where these materials may be present.
- Solvent-based or water-based solutions containing solvents may damage the pump, hoses, and other components. Do not assume chemical compatibility. Contact your distributor or Hydro-Force if you have questions regarding the compatibility of your chemicals with the machine.
- Do not clean with solutions that are at temperatures above 130°F.
- Rinse the solution tank, chemical system, and pump with fresh water after each day's use.
- Do not allow pump to run dry. Always maintain adequate solution level to supply solution pump.
- HP hoses may rupture if worn or damaged. Do not use HP solution hoses if hose covering is cut, bulging, or otherwise damaged. Examine HP solution hoses daily and replace or repair hoses as needed.
- Use a Hydro-Filter II and clean the recovery tank daily to keep pump-out filter and pump from becoming clogged. Store the MX200 with the recovery tank lid open.
- Keep Vacuum Inlet Filter clean and check float for proper operation. Do not operate the MX200 without the Vacuum Inlet Filter in place. **Use defoamer to eliminate foam build-up during cleaning and prevent foam/moisture from entering vacuums.**

## **WARNING**

**Use common sense to protect yourself and others while using this equipment.**

- Keep pets and children away from the machine when in use.
- Keep all body parts, hair, and loose clothing away from openings and moving parts. Always wear appropriate work clothing and safety equipment when operating unit.
- Use extra care when cleaning on stairs. Wet carpet on stairs can be slippery.
- Do not move the MX200 up or down stairs when tanks are full of water. Drain solution and recovery tanks, and secure base latches before moving unit up or down stairs. Lift using only the machine handles designed & designated for moving and lifting.
- Water may be spilled, drip, or be exhausted from vacuums during operation. Place unit in area where water will not cause damage or use drop cloth to protect surfaces.

## Vacuum Connections

The MX200 has a unique vacuum system which allows you to connect your vacuums in either parallel or in series. Vacuum connections can be changed quickly, with only a screw driver. While there is debate on which vacuum alignment provides the best extraction, this much is true:

- Two vacuums in series: The vacuum lift is increased by 1.6 times the rating of a single vacuum, while the air flow stays the same as a single vacuum.
- Two vacuums in parallel: The vacuum air flow is increased by 2.0 times the rating of a single vacuum, while the lift stays the same.

Air flow is usually measured in cubic feet per minute, indicated as CFM. Lift is usually measured in inches of water column, indicated as "H<sub>2</sub>O or "WC.

### To connect vacuums in parallel:

1. Connect the discharge / exhaust hose from vacuum #1 to the exhaust pipe on machine base.
2. Place the rubber stopper into the vacuum inlet port of vacuum manifold number two.
3. Open vacuum gate valve and attach the Gatekeeper to prevent accidental valve closure.

When connected in parallel, both vacuums must be running during cleaning. Vacuums cannot be operated individually.

### To connect vacuums in series:

1. Connect the discharge / exhaust hose from vacuum #1 to the vacuum inlet port of vacuum manifold number two.
2. Place rubber stopper into the exhaust pipe on machine base.
3. Remove Gatekeeper and close vacuum gate valve.

When connected in series vacuums can be operated individually if desired during cleaning.

**NOTICE** Always secure the Gate Valve Open with the Gatekeeper when connecting the vacuums in Parallel. Closing the Vacuum Gate Valve with the hoses connected in the Parallel configuration may cause damage to Vacuum #2.

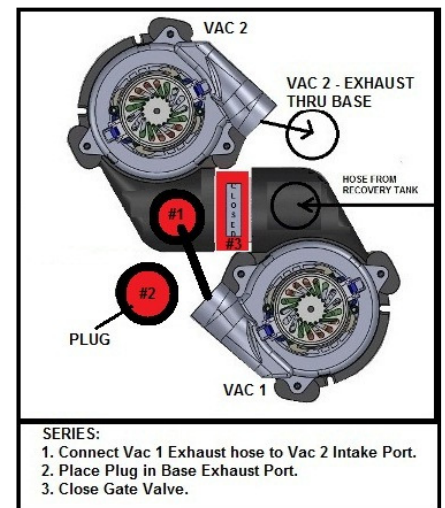
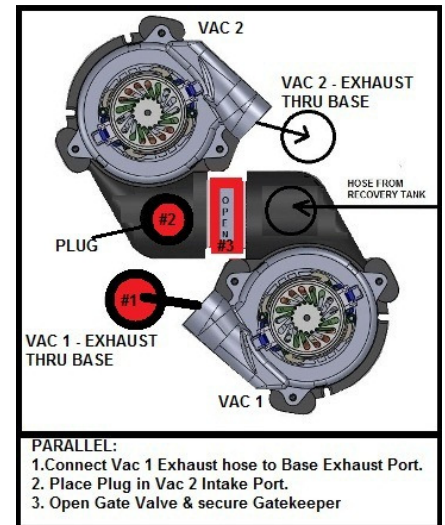



# Operation Procedures

*Knowledge of the proper operation of the MX200 is required to ensure user safety and efficient performance of the extractor.*

## SET UP AND OPERATION

### 1. Electrical Cords:

One 25' power cord is supplied with the standard Nautilus MX200. This cord powers vacuum #1, vacuum #2, the Solution Pump, and the cooling fan and the waste pump if so equipped.

A second cord is added if equipped with the optional 1750W heater. Cord#2 will power the heater and the waste pump if so equipped.

The amperage required by each cord requires that the two cords be plugged into separate circuits:

- Cord #1 (Left side) Must be plugged into a 20amp circuit.
- Cord #2 (Right side) Units with heater only, Cord #2 can be plugged into a 15amp circuit. Units with the heater and the optional APO, it must also be plugged into a 20amp circuit when using both the heater & waste pump.

**20amp circuits are usually found in kitchens and bathrooms.** An overloaded circuit will not always trip the circuit breaker immediately, but it may not provide sufficient voltage for proper operation and the breaker may trip eventually.

On dual cord units, plug the two power cords into two outlets from different circuits. If the Dual Circuit Indicator green light fails to light, you may be on the same circuit and may need to select a different plug for one of the cords. If the Dual Circuit Indicator green light comes on, you are plugged into two different circuits. Proceed with your set-up procedure.

**(Dual Circuit Indicator light may take up to 30 seconds to recognize the two circuits and turn ON.)**

If a circuit breaker trips or the pump circuit breaker trips during operation, reset the breakers and move the cord to another outlet as needed.

## NOTICE

When operating the MX200 with the optional 1750W heater **DO NOT** turn the heater on until after the pump has been primed and solution hose and tool connected – Steps #3, #4 & #5.

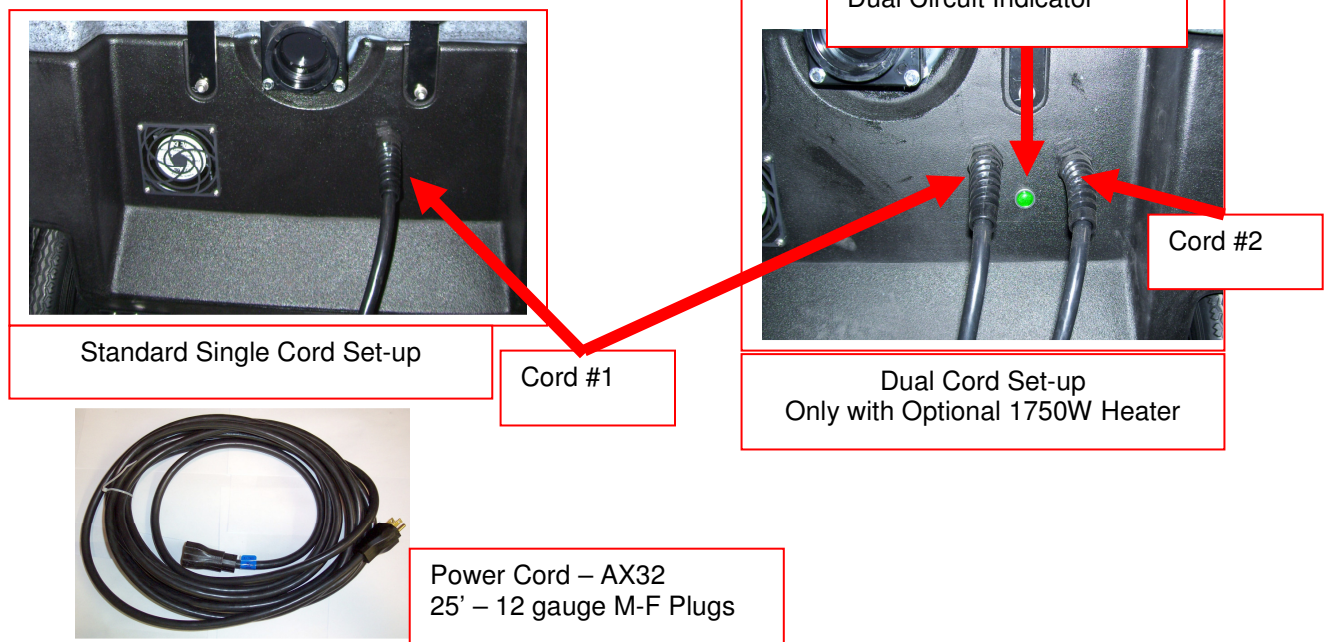



## 2A. Water Supply & Chemical Mixing– Manual Fill:

- Pour up to 12 gallons of hot water into the solution tank at the front of the machine. **The water temperature cannot exceed 130°F.**
- Measure and add the appropriate amount of the desired liquid chemical to the water in the solution tank. The amount of chemical will vary depending on the type of chemical used, the amount of water in the tank, and the material being cleaned; consult the chemical packaging for specific mixture ratios.
- Powdered chemicals should be dissolved in water before adding to the water in the solution tank.

**NOTICE** DO NOT RUN OUT OF WATER WHILE USING THE MACHINE! Ensure that the tank contains enough water to complete each job. If the water level is low: stop cleaning, turn off the pump, and refill the tank. Running the pump dry will damage the pump and void the warranty.



Pour appropriate amount of hot water into solution tank



Add appropriate amount of chemical to water in solution tank

## 2B. Optional Auto-Fill System - Water Supply & Chemical Dilution:

- The chemical dilution rate is controlled by the metering tip, and the dilution rate can only be changed by changing the metering tip (See “How to Change the Metering Tip” on Page 11 for instructions.)

### Chemical Feed Setup:

- Remove the chemical feed hose from the solution tank. Make sure float is attached to valve and hanging freely, above the bottom of the solution tank. Adjust float height to maintain adequate water level.
- Place the end of the chemical feed hose into a container of liquid chemical.
- If the tip is removed, and the proportioning system operated with no tip, the dilution rate will be 8:1 (the equivalent to adding 16-1/4oz of chemical to each gallon of water.)
- The recommended tip for use with the MX200 is the turquoise tip with a dilution rate of 256:1. This means that for each gallon of water flowing into the machine, 1/2 ounce of chemical will be added.
- **If a fresh water rinse with no chemical is desired, simply leave the chemical feed hose inside the solution tank.**

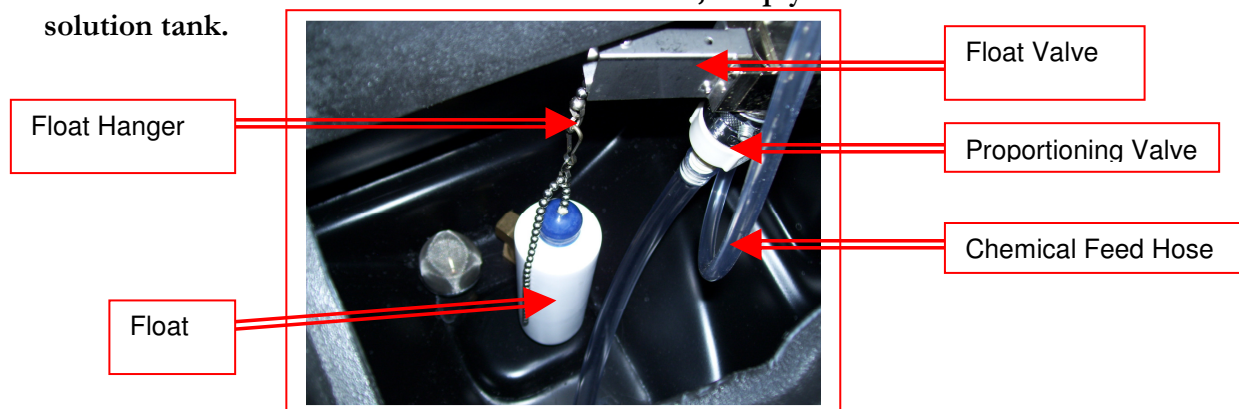

**How to Change the Metering Tip:**

- Remove the chemical feed hose from the barb on the side of the proportioning valve.
- Unscrew and remove the old tip.
- Screw in the proper tip for your chemical tip and place the hose back on the barb

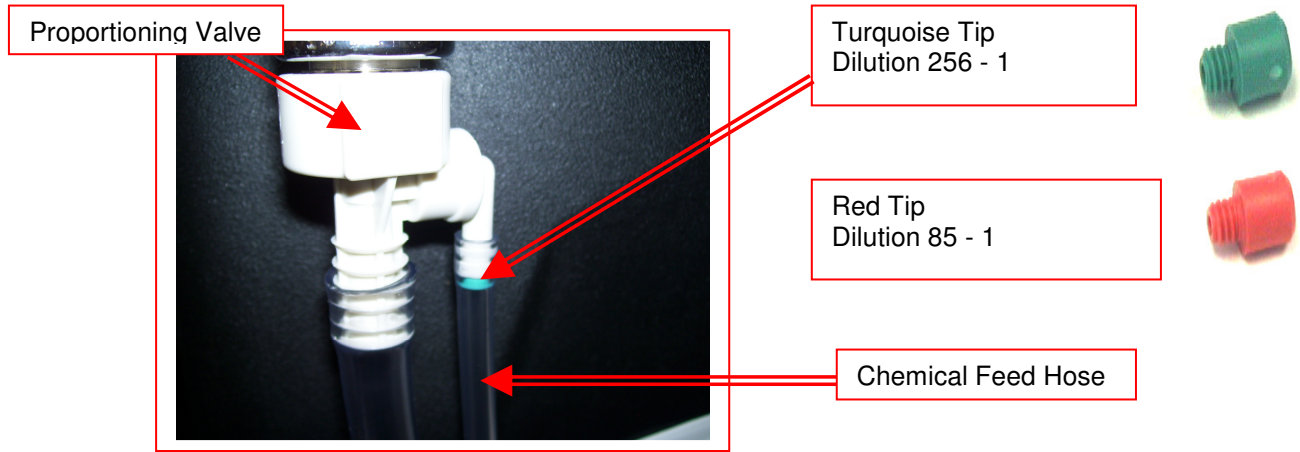

**Metering Tip Kit (Hydro-Force Item# PDE001)** contains 14 different colored metering tips, allowing dilution rates from 11:1 up to 427:1. Refer to the chart below to select the tip that meets the dilution rate for your chemical application.

- For example: if you require 1-1/2 ounces of chemical per gallon of water, change to the red metering tip with the dilution rate of 85:1.
- The dilution rates are based on chemicals with water-like viscosity. Thicker (more viscous) chemicals will dilute at a different rate.
- For powdered chemicals, a liquid concentrate must be made. Mix the concentrate according to the manufacturer’s directions, and then select the appropriate metering tip.
- Contact your distributor or Hydro-Force if you have questions about your chemical.

**Metering Tip Application Chart:**



**Metering Tip Kit – PDE001**

TIP COLOR	CHEMICAL DILUTION RATES	
	OZ / GAL	(RATIO)
TAN	0.30	(427:1)
ORANGE	0.40	(320:1)
<b>TURQUOISE</b>	<b>0.50</b>	<b>(256:1)</b>
PINK	0.75	(170:1)
LIGHT BLUE	1.00	(128:1)
BROWN	1.12	(114:1)
RED	1.50	(85:1)
WHITE	1.75	(73:1)
GREEN	2.00	(64:1)
BLUE	2.50	(51:1)
YELLOW	3.75	(34:1)
BLACK	5.00	(26:1)
PURPLE	8.50	(15:1)
GRAY	11.50	(11:1)
NO TIP	16.25	(8:1)

## Water Supply:

- Once the correct metering tip is in place:
  - Connect the Auto-Fill Water Supply Hose to the water inlet (the male quick-connect on the front of the machine.)
  - Connect the other end of the hose to a water faucet, and then turn on the water.
- Hot water can be used as long as the temperature does not exceed 130°F.
- Faucet adapter kits (Hydro-Force item #AX21 & AX22) are available that allow connection to different types of faucets if needed.



Connect the Auto-Fill Water Supply Hose to a faucet and turn on the water



Connect the Auto-Fill Water Supply Hose to Solution Inlet (Male quick connect on the front of the machine.)

3/8" id X 25' with F Quick Connect & F Garden Hose Fitting

Chemical Feed Hose

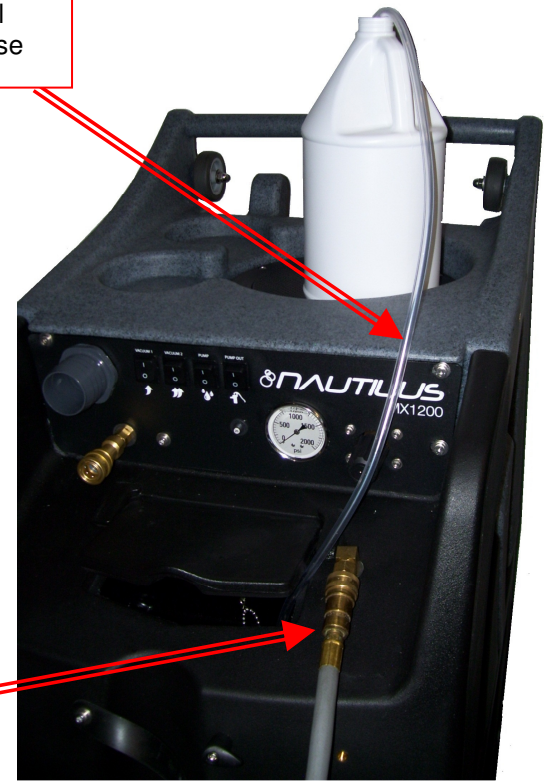

Float Valve

## To adjust the water level in the solution tank:

- Turn off the water supply.
- Adjust the length of the chain connecting the float bottle to the float valve. Unhook the float from the beaded chain on the valve. Unsnap the hook from the beaded chain on the float.
  - Move the bottle down to decrease the water level.
  - Move the bottle up to increase the water level.
- Snap the back onto the float chain & hook the float back onto the valve chain.
- Turn the water supply back on.

If the chemical is not drawing, or if the tank is not filling or is overflowing, refer to the trouble shooting guide, or contact your distributor for assistance.

Float Hanger Hook



Float Bottle



### 3. Priming the High-Pressure Pump:

Once water is in the solution tank, the high pressure pump must be primed:

- There is a priming hose included with the machine. Connect the priming hose to the solution outlet – female quick connect on the front of the machine.
- Turn on both vacuums and the solution pump. Insert the end of the priming hose into the vacuum inlet port on the front of the machine and cup your hand around the hose to block off the vacuum inlet with your hand. The vacuum will pull solution through the pump and priming hose into the vacuum tank.
- Turn off the pump and vacuums. Disconnect the priming hose. You can now continue your set-up. As long as there is solution in the tank, the pump should remain primed.

If the pump still does not prime, or if flow is low or unsteady, check the hose from the solution tank to the pump (as well as the filter) for clogging, kinks, or restrictions. Clean or replace hose and/or filter and repeat the priming procedure.

If you are having trouble with the pump, refer to the trouble shooting guide or contact your distributor for advice or assistance.



PUMP PRIMING HOSE  
NM5080



### 4. Connection of Solution Hose:

Connect the high pressure solution hose to the solution outlet (female quick connect on the front of the machine). Connect the other end of the hose to the male quick connect on the cleaning tool. When you are ready to start cleaning, turn the solution pump switch to the ON position. The pressure is preset, there is no pressure adjustment to be made.



HP Solution Hose Assembly – AH79D  
1/4" id X 25' with M-F Quick Connects

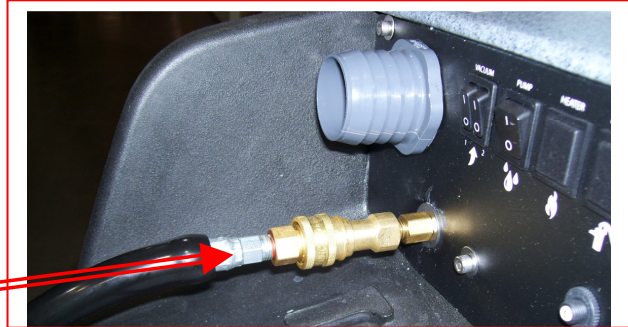

Connect the male end of the HP Solution Hose Assembly to the female solution outlet fitting on the machine. Connect the female end to the cleaning tool.

## 5. Optional 1750W Heater Operation:

**NOTICE** To prevent damage to the heater, the heater must have water in it before it is turned ON. Fill solution tank, prime the pump and connect solution hoses before turning heater ON.

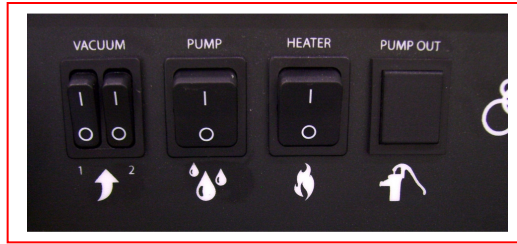

While the heater allows for maximum operating temperature of approximately 190°F, the temperature of the cleaning water delivered to the tool is dependent on two factors:

- The starting temperature of the water: Starting with hotter water will require a smaller temperature increase from the heater to reach the maximum temperature.

**NOTICE** The water temperature in the solution tank cannot exceed 130°F.

- Flow rate: The lower the flow rate of the water through the heater, the more time the water will be inside the heater. The water will have more time to be heated and can reach a higher temperature. High water usage and flow rate will not allow the water enough time to be heated and the temperature of the water delivered to the tool will be much lower.

The flow rate can be lowered by putting smaller jets in the cleaning tool and by reducing the amount of time the wand is sprayed. Taking additional drying strokes without spraying water between spraying strokes will help increase the potential temperature rise.

## 6. Connection of Vacuum Hoses:

The vacuum connection port on the machine can be either a 2" hose barb or 2" male Flash Cuff. Both are included with your MX200. The desired connector can be threaded into the vacuum port on the front of the machine.

A 2" female Flash Cuff 1-1/2" hose adapter is also included to connect the 1-1/2" vacuum hose to the 2" male Flash Cuff on the machine.

A 2" hose cuff for 1-1/2" vacuum hose is included to connect the 1-1/2" vacuum hose to the 2" hose barb on the machine.

With the proper cuff attached to the 25' Vacuum Hose, the 25' vacuum hose is then connected to the vacuum connection port on the MX200. The other end with the 1-1/2" cuff is connected to the cleaning tool.

When ready to begin cleaning, turn both vacuum switches to the ON position. If connected in series, the MX200 can be operated with only one vacuum for cleaning delicate fabrics. (See Vacuum Connection instructions on Page 8) In most situations you will turn both vacuum switches ON.



Vacuum Connection with standard barb and vinyl cuff

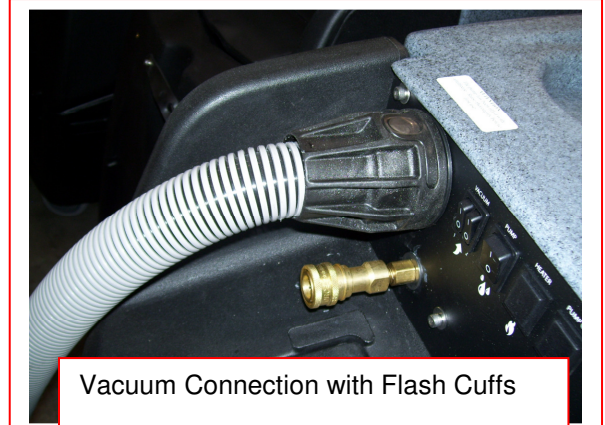

Vacuum Connection with Flash Cuffs



## 7. Optional Foam Downer:

A key problem with portable extractors is that they have small tanks where foam dissipates slowly. If you have had issues with foam or are anticipating foaming problems, you will want to use a Foam Downer.

Foam can be drawn into the vacuums before the vacuum shutoff closes. Foam and water blowing out the vacuum makes a big mess, can decrease vacuum lift and damage the vacuum motors.

The Foam Downer kills foam as waste water enters the machine. Place a container of liquid defoamer on the top of your MX200. The vacuum air flow siphons the liquid defoamer through Foam Downer into the vacuum tank, breaking down the foam before it can cause any damage or make a mess.

- Mounts and is ready to use in seconds
- Uses defoamer very economically
- NO LABOR is involved to spray or spread defoamer – it's all automatic
- Keeps silicone defoamers off the floor where they can cause resoiling problems

The Foam Downer is an attachment that allows the vacuum to draw a small amount of defoamer in a constant slow flow into the waste tank of the Nautilus. We recommend using a diluted defoaming solution of four ounces of defoamer to one gallon of water (1-32). Place the draw tube into the gallon of diluted defoamer and open the needle valve one half turn as your starting point. If this is not sufficient to break down the foam you can open the valve more or add more defoamer to the water to make a stronger solution. With the valve open one half turn it will take approximately one half hour to drain the gallon of diluted defoaming solution.



FOAM  
DOWNER

AH17



FOAM DOWNER cannot be used with 2" Male Flash Cuff connector on machine. Remove 2" Male Flash Cuff and install 2" hose barb as needed.



HOSE HOOK  
AH95



## 8. Connection of Optional Pump-Out Hose:

If your machine has the Optional Auto Pump-Out System you may want to connect the Pump-Out Hose. The pump-out hose is a 50' section of 3/4" garden hose. (Use of smaller diameter hose may reduce flow.)

- Remove the cap from the pump-out outlet fitting on the back of the machine.
- Connect the pump-out hose to the outlet fitting.
- Place the other end of the hose in a commode or drain connected to the sanitary sewer system.
- Secure hose end to prevent movement during pumping.

### NOTICE

- Use defoamer to prevent foam build-up in recovery tank during cleaning and to keep foam/moisture from entering vacuums.
- Use Hydro Filter II inline filter to trap and remove debris from the waste water before it enters the recovery tank. Excess debris in recovery tank may clog Pump-Out filter. Clean Filter as needed during use.
- Do not turn the Waste Pump switch ON unless pump-out hose is connected and has been routed to a proper drain.  
The Waste Pump does not use a float switch and will run as soon as the Waste Pump switch is turned ON. It is made to run continuously while cleaning, as this type diaphragm pump can run dry without damage.

When ready to begin cleaning, turn the Waste Pump switch to the ON position.



Pump-out Filter

Connect the Female Garden Hose Fitting end of the Pump-out Hose to the outlet fitting on the back of the extractor. Place the other end of the pump-out hose in a sanitary drain.

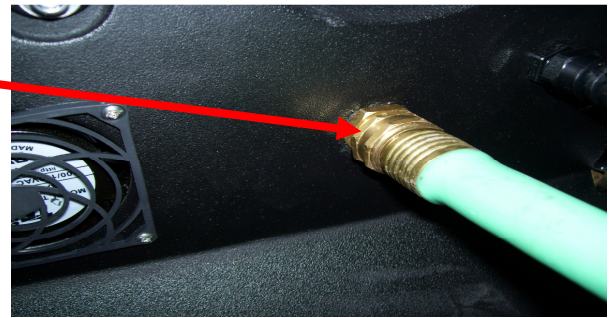

If not using the waste pump-out, the pump-out hose does not need to be connected. When the recovery tank fills during cleaning, the float assembly in the vacuum inlet filter will rise and will automatically shut off the vacuum air flow to prevent the recovery tank from overflowing and waste water from getting into the vacuums. When this occurs:

- Immediately shut off the vacuum switches.
- Drain the recovery tank.
  - Turn off the pump switch while draining the tank.
  - Turn pump switch back upon resumption of cleaning.
- Close the drain valve and turn the vacuum switches back on when ready to resume cleaning.

If the pump-out or vacuum shutoff is not working properly, refer to the trouble shooting guide or contact your distributor for advice or assistance.



Float Shutoff Assembly



Draining the Recovery Tank

## Shutdown Procedures:

- If using the optional auto-fill system, turn the water supply off before finishing each job. This will allow use of the water and chemical already in the tank, and will reduce the amount of excess water to be disposed of later.
- If using the optional 1750W heater, turn the heater off before finishing each job. This will allow the water to cool the heater as you finish the job.
- When finished cleaning, turn off all switches.
- If the optional auto-fill system was used and there is still water in the solution tank, push the float down to release the water inlet hose pressure before disconnecting the hose from the faucet. Disconnect the water inlet hose from the quick-connect on the front of the machine.
- Disconnect the solution hose and vacuum hose from the cleaning tool. Pull valve trigger to release pressure from the hose before disconnecting solution hose from cleaning tool.
- If a Hydro Filter II inline filter was used, disconnect the Hydro-Filter II from the vacuum hoses and clean the filter as needed. Replacement filter screens are available (AC10C.)
- Disconnect the vacuum hose and solution hose from the machine.
- If water remains in the solution tank, use the vacuum hose and vacuum the excess water from the tank. 
- If the optional auto-fill system was utilized, place the chemical feed hose back into the solution tank.
- If the optional Auto waste pump-out system was used:
  - Turn the waste pump switch “on” to pump out any remaining water from the recovery tank.
  - Turn switch off, remove the pump-out hose from the outlet fitting and replace the cap.
  - Roll up hose toward drain to remove remaining water from hose.
  - Connect ends of hose together to prevent dirty water from dripping from hose during transport.
- Disconnect the power cords from the outlets and from the machine.
- Remove the float shutoff assembly from the recovery tank and clean vacuum shutoff filter as needed. Clean Pump-Out filter screen. Replace shutoff assembly and tank lid.
- Drain any remaining water from the recovery tank and dispose in sanitary drain. Do not use the same bucket to drain the tank that you use to fill the tank.
- Roll up all hoses and cords.  
Collect and store extractor, all tools, and accessories.

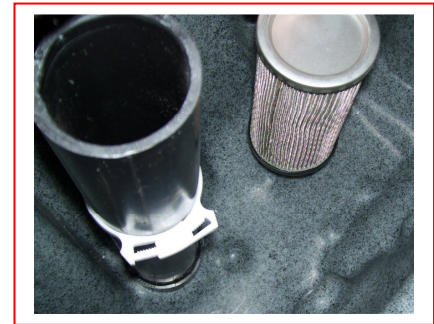



# Accessory Storage Options:

The MX200 is designed to make it easier for the operator to transport the machine and the most common cleaning accessories.

## Bucket & Sprayer Storage

The top of the MX200 is sized and recessed to hold a five gallon bucket or two one-gallon chemical bottles as well as two 2QT sprayers.

## Power Cord Storage

The back of the MX200 has two sets of cord wraps to hold two 12/3 x 25' power cords.

## Carpet Wand Storage

The front of the MX200 is designed to hold a S-Bend Carpet wand and has two straps to hold it securely. Optional strap for larger wands available

## Other Tool & Hose Storage

Each side of the MX200 has a set of molded in threaded inserts to which holders can be attached to hold other accessories or supplies making it much easier to move around. Four 1/4-20 x 5/8" mounting screws & washers included.



Wand Holder Straps

Molded in Threaded Inserts for Side Mount Holders

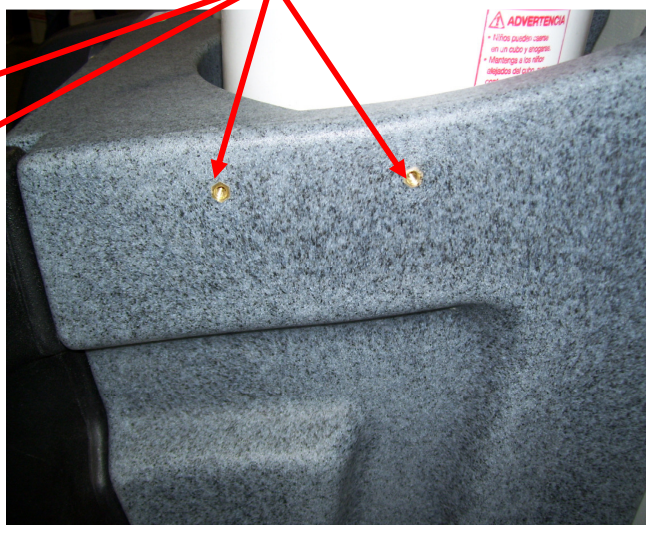
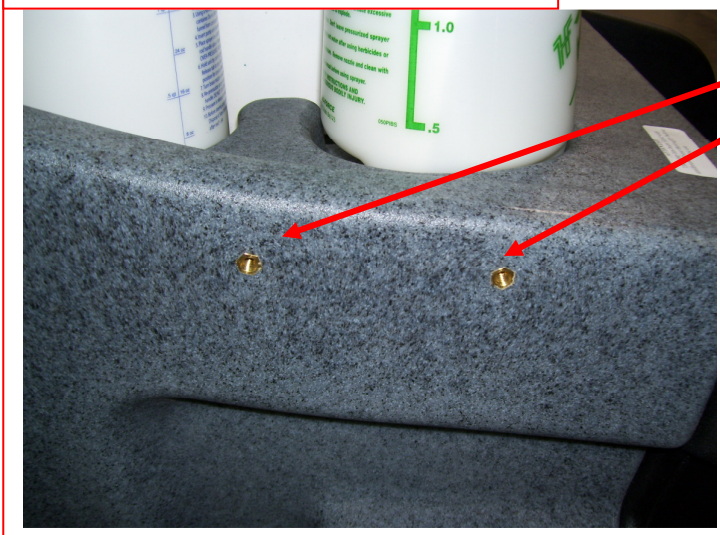

# Troubleshooting

## Troubleshooting – Nautilus MX200

Problem	Cause	Solution
Machine not turning on - No power	Building circuit breaker tripped.	Reset breakers or move cords to other outlets
	Faulty power cord	Replace cord (AX32)
	Faulty switches or internal wiring	Check wiring & test switches - Repair as needed *
Solution Pump not running	Building circuit breaker tripped.	Reset breakers or move cords to other outlets
	Pump circuit breaker tripped	Reset breaker – Check available circuit power & pump
	Faulty power cord	Replace cord (AX32)
	Faulty switches or internal wiring	Check wiring & test switches - Repair as needed *
	Pump motor breaker tripped	Push in reset button on pump motor &/or external breaker
	Pump motor faulty	Replace pump motor (PT061)
	Pump seized - trips breaker	Repair or replace pump head (PT047) or bearing (PT030) - Check motor and/or replace complete pump & motor assy. (AP51)
Low Solution Pressure and/or Pulsation	Jets too large for pressure desired	Check jets size & flow rates use smaller jets or lower pressure
	Jets worn allowing too much flow	Replace jets
	Solution inlet filter plugged	Clean or replace filter
	Hose from solution tank restricted	Repair or replace hose
	Pump intake hose or fittings leaking	Repair or replace hose. Tighten clamps or replace fittings
	Pressure regulator sticking	Lube seal on regulator piston
	Pressure regulator faulty	Repair or replace pressure regulator (PT048A or PT048)
	Filter screen or jets plugged on tool	Clean out filter or jets
	Solution tank empty	Add water to tank - Check & repair auto fill assembly
	Pump not primed	Perform pump priming procedure
	Pump faulty	Repair or replace pump (PT047 or AP51)
	Tool valve faulty	Repair or replace valve
	Quick connects or hoses restricted	Clean out or replace quick connects and/or hoses
Can't connect solution hose to machine	Pressure in lines	Release pressure
	Quick connects faulty	Replace quick connects (AH101B, AH102B)
	Wrong style/size quick connects	Replace quick connects to match connects on machine
<p><b>⚠️WARNING</b>: To reduce the risk of fire electrical shock or injury repairs to wiring should only be performed by experienced service technicians.</p> <p>* If you are not experienced in checking electrical wiring contact your nearest authorized service center to perform tests and repairs to wiring and switches.</p>		



<b>Problem</b>	<b>Cause</b>	<b>Solution</b>
Dual Circuit Indicator Not Lighted	Cords on the same circuit	Move one cord to outlet on different circuit
	No voltage from one/ both outlets	Check circuit breakers – Reset breakers or move cords
	Light Bad	Replace Light
	Dual Circuit Indicator Bad	Replace indicator
	One/Both Outlets Wired wrong	If hot & neutral sides switched on outlet, machine will work, but light will not turn ON.
Pump-out not working	Building circuit breaker tripped.	Reset breakers or move cords to other outlets
	Faulty power cord	Replace cord (AX32)
	Faulty switches or internal wiring	Check wiring & test switches - Repair as needed * (NM5714)
	Pump-out pump faulty	Replace pump-out pump (AP37)
	Pump-out filter clogged	Clean pump-out filter - Keep recovery tank clean – Use Hydro-Filter AC10
	Discharge hose restricted	Un-kink, clean out or replace hose
	Pump-out pump clogged	Remove and clean out pump
Vacuum Motor not running	Building circuit breaker tripped.	Reset breakers or move cords to other outlets
	Faulty power cord	Replace cord (AX32)
	Faulty switches or internal wiring	Check wiring & test switches - Repair as needed *
	Vacuum motor faulty	Replace vacuum motor (AV010)
Loss of Vacuum	Vacuum motor faulty	Replace vacuum motor (AV010)
	Vacuum motor gasket damaged	Replace gasket (PA010A)
	Recovery tank lid gasket damaged	Replace gasket (NM5718)
	Drain valve open	Close valve
	Drain valve leaking	Repair or replace drain valve (PEA11)
	Vacuum motor hoses loose / leaking	Reconnect or replace vacuum motor hoses
	Vacuum Valve in wrong Position	Check Vacuum Gate Valve Position. – PAGE 8
	Vacuums not connected properly	See vacuum connection instructions – PAGE 8
	Vacuum hose or tool clogged	Clean out vacuum hoses and tool
	Vacuum hoses or cuffs leaking	Replace vacuum hoses, cuffs & connectors as needed
	Recovery tank full	Drain tank
	Float shutoff filter clogged	Clean float shutoff filter
	Float stuck in float shutoff	Repair or replace float shutoff
	Pump-out Pump faulty	Repair or replace pump out pump (AP37)
	Recovery tank damaged	Replace recovery tank
Chemical not feeding	Solution tank not filling	Check & repair auto fill assembly
	Chemical hose restricted	Un-kink, shorten, clean out or replace hose
	Filter screen plugged	Clean or replace filter (PDE100-11P)
	Low Incoming Water Pressure	Move bottle & shorten chemical hose to improve draw – Find other water source.
	Wrong size metering tip	Change metering tip
	Chemical proportioner faulty	Replace chemical proportioner (PDE61-22-3)
	Check valve in filter faulty	Replace filter (PDE100-11P)
<p><b>⚠WARNING</b> : To reduce the risk of fire electrical shock or injury repairs to wiring should only be performed by experienced service technicians.  * If you are not experienced in checking electrical wiring contact your nearest authorized service center to perform tests and repairs to wiring and switches.</p>		

Problem	Cause	Solution
Tool won't spray - low or uneven spray	Jets clogged	Clean out or replace jets
	Inline filter clogged	Clean out or replace filter
	Jets worn	Replace jets
	Jets not aligned properly	Re-align jets
	Tool valve faulty	Repair or replace valve
	Quick connects or hoses restricted	Clean out or replace quick connects and/or hoses
Solution Tank not filling	Water source turned off	Turn on faucet or find other water source
	Float not on valve arm	Reconnect float to valve arm - Adjust to proper height/level
	Float valve faulty	Repair or replace float valve
	Water hose restricted	Un-kink, clean out or replace hose
	Water Pressure too high	Use pressure regulator on auto-fill hose
	Quick connects faulty	Clean out or replace quick connects (AH101B, AH102B)
Solution tank overflowing	Float too heavy/ Filled with water	Replace float
	Float & chain tangled	Make sure float chain free & hanging properly
	Float too high	Adjust chain to set float at proper level
	Water Pressure too high	Use pressure regulator on auto-fill hose
	Float valve faulty	Repair or replace float valve
Chemical Jug Filling with water - Overflowing	Foot valve in Filter stuck	Clean out foot valve and filter
	Foot valve in Filter faulty	Replace foot valve and filter (PDE100-11P)
Water Not Getting Hot	Faulty switches or internal wiring	Check wiring & test switches - Repair as needed *
	Temperature Switch faulty	Replace Temperature Switch On Heater
	Water Being used too fast	Re-jet wand – Slow the flow - Take extra drying strokes
	Only one Heater Switch ON	Turn Both Heater switches ON
	Heater Faulty	Replace Heater (NM5044)
<p><b>⚠️WARNING</b> : To reduce the risk of fire electrical shock or injury repairs to wiring should only be performed by experienced service technicians.</p> <p>* If you are not experienced in checking electrical wiring contact your nearest authorized service center to perform tests and repairs to wiring and switches.</p>		

- Contact your distributor for additional troubleshooting assistance, to order parts, or for advice and assistance in performing necessary repairs.

# MX200

## Solution Flow Path

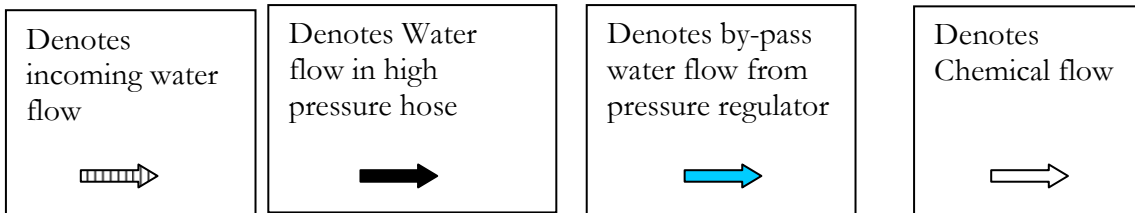
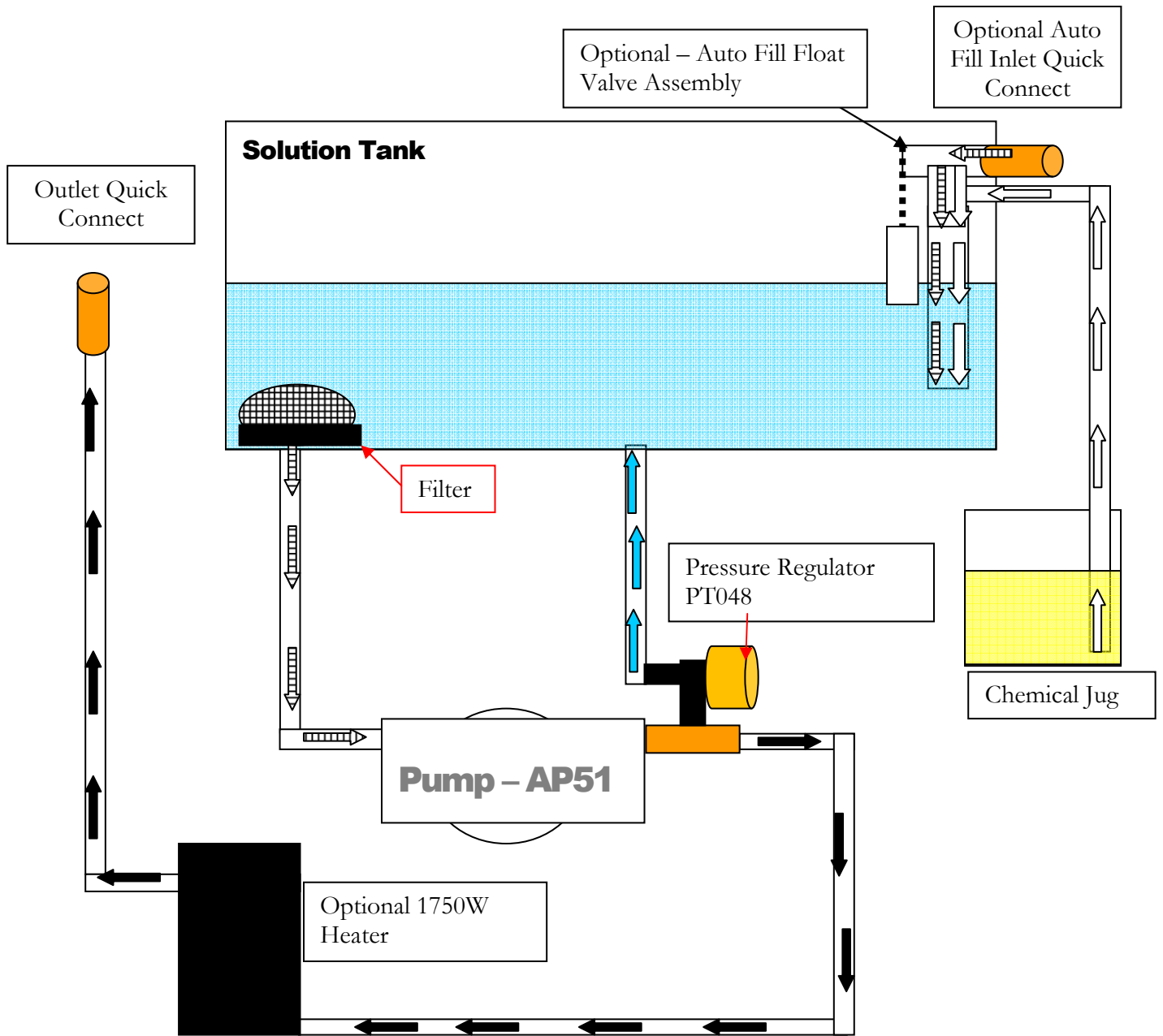

# MX200

## Wiring Diagram – Cord #1 (No Heater)

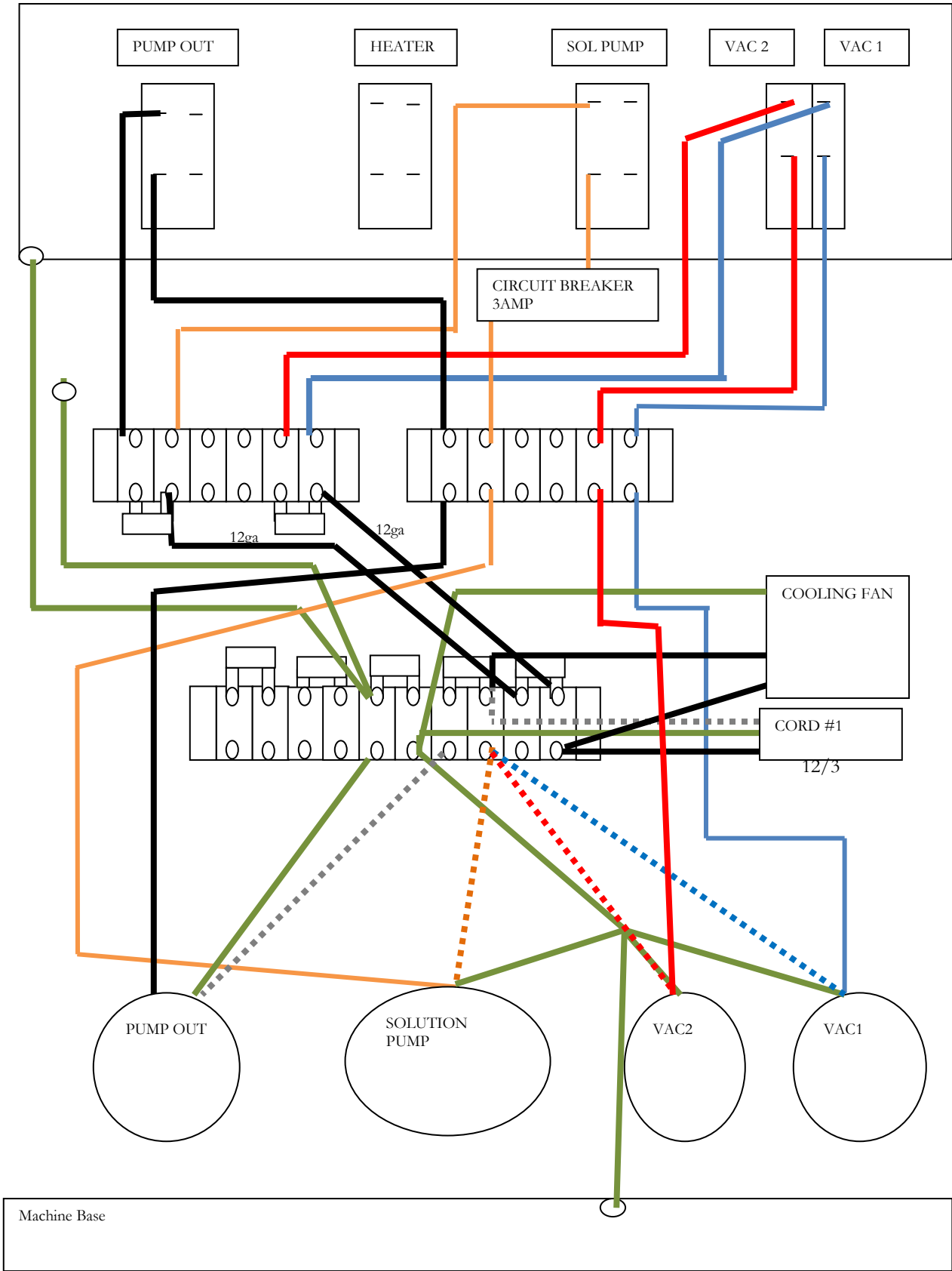

# MX200

## Wiring Diagram – Cord #1 (With Heater)

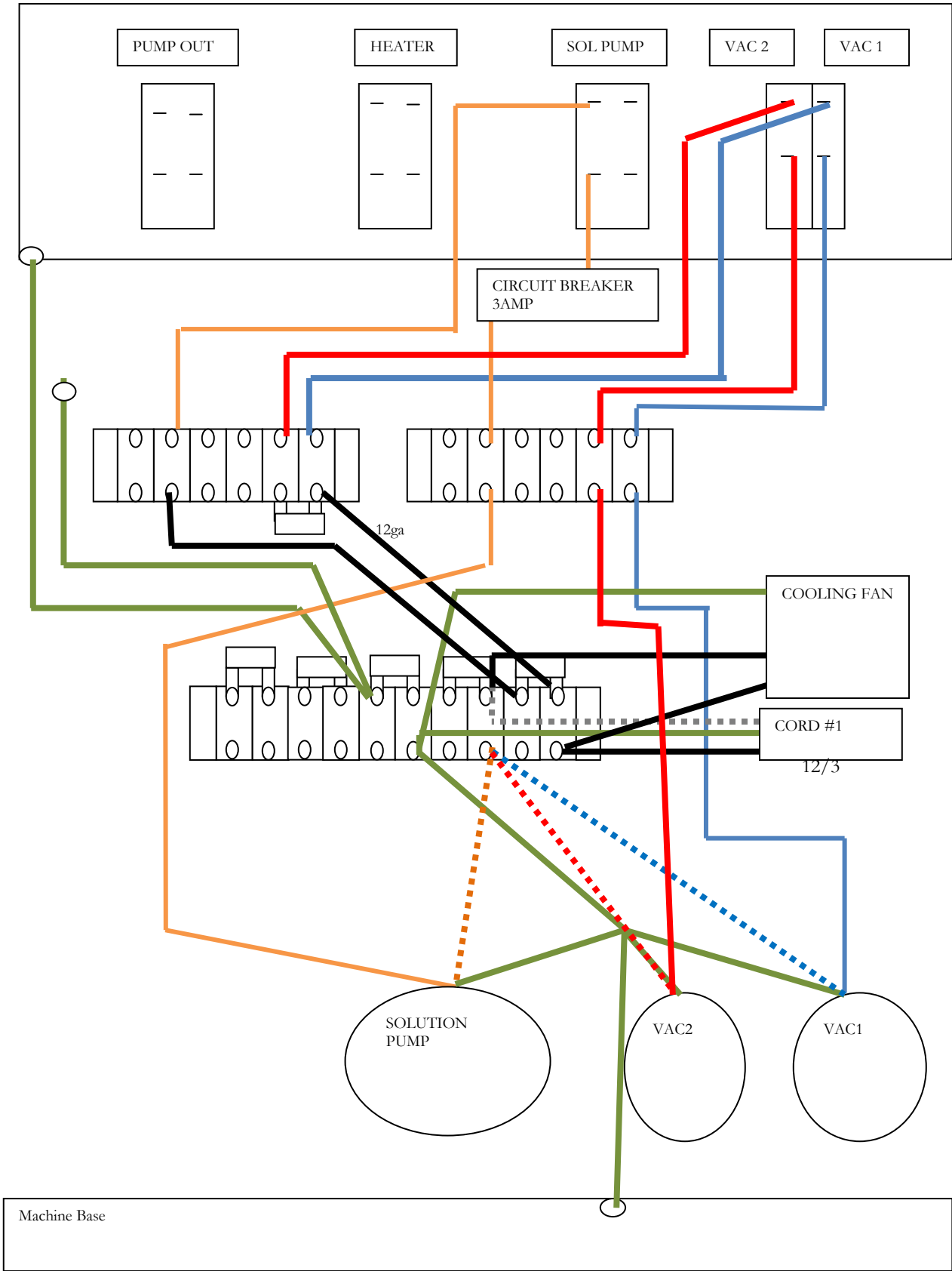





# NAUTILUS MX200 SWITCH PANEL:

(Shown with optional Heater and Pump-Out switches)

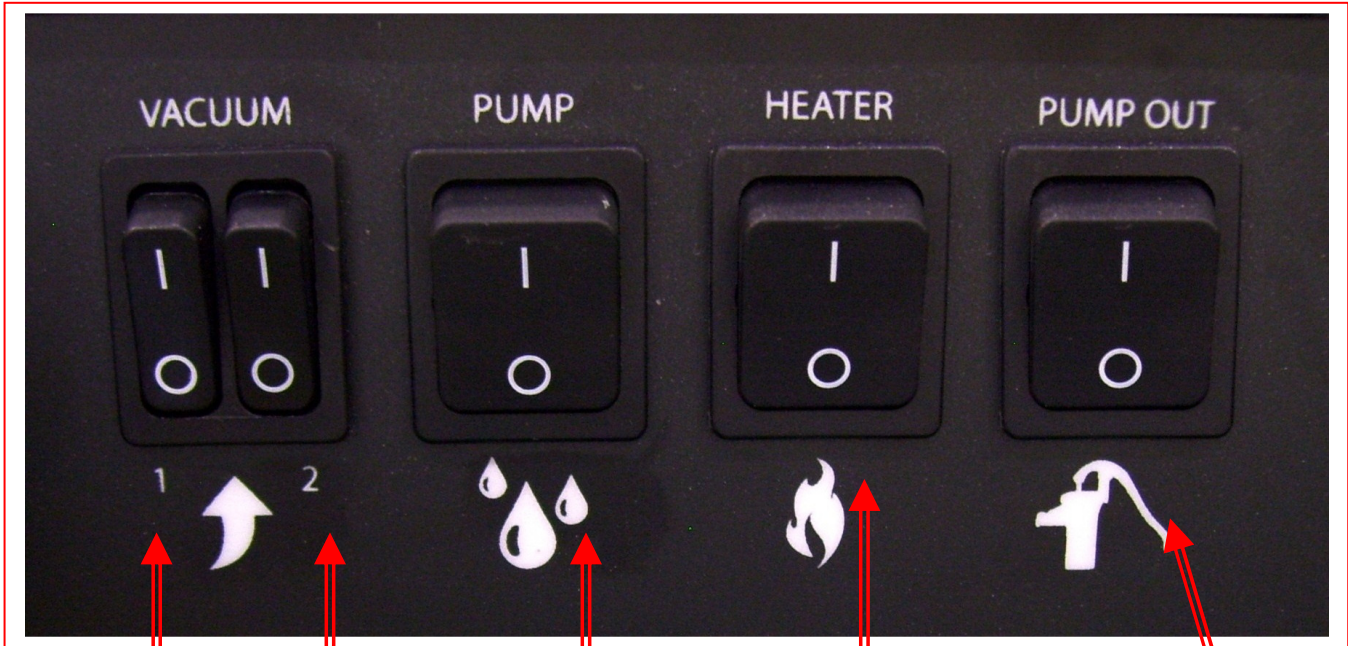

### Vacuum #1 – Power from Cord #1.

When the switch is turned to the ON position power is supplied to the vacuum motor. (2-Stage Vacuum)

### Vacuum #2 – Power from Cord #1.

When the switch is turned to the ON position power is supplied to the vacuum motor. (2-Stage Vacuum)

### Solution Pump Switch – Power from Cord #1.

When the switch is turned to the ON position power is supplied to the solution pump motor. When not using solution (Extracting Only) do not turn this switch ON.

### Cooling Fan – Power from Cord #1.

The cooling fan is not controlled by any switch. As soon as Cord #1 is plugged in the cooling fan will turn on to exhaust air from the base.

### Optional Heater – Power from Cord #2.

When the switch is turned to the ON position power is supplied to the 1750W heating element.

### OPTIONAL - Waste Pump Switch Power from Cord #1 on Unheated Units Power from Cord #2 on Heated Units

#### **NOTICE**

Do not turn Waste Pump Switch ON unless a hose is connected to the Pump-out Outlet port. For pump protection there is a pressure switch which will turn the waste pump off if the pressure in the discharge line gets too high, as it would if the pump was turned on while the outlet cap was still in place.

## Maintenance

*Proper maintenance is required to keep the MX200 operating properly, prevent downtime and to extend the life of your equipment.*

### **⚠️ WARNING**

*This machine is an electrical appliance. Care must be taken to reduce the risk of electrical shock.*

### **⚠️ WARNING**

Disconnect electrical power before performing any service or maintenance inside machine base or before testing or repairing switches or power cords. Failure to do so may result in severe personal injury or death.

OPERATION	INTERVAL	Page #
CLEAN CHEMICAL FEED FILTER & FOOT VALVE	Daily – After Each Job	28
CLEAN VACUUM SHUTOFF ASSEMBLY SCREEN	Daily – After Each Job	28
CLEAN HYDRO-FILTER II	Daily – After Each Job	29
RINSE OUT RECOVERY TANK	Daily	29
CLEAN WASTE PUMP-OUT PUMP	Daily	30
FLUSH SOLUTION TANK AND PUMP	Daily	30
CLEAN PUMP-INLET FILTER	Weekly – As needed	31
FLUSH CHEMICAL SYSTEM	Monthly	32
CLEAN DRAIN VALVE	As needed	33
STORAGE PREP – FREEZE PROTECTION	As needed	34

# CLEAN CHEMICAL FEED FILTER & FOOT VALVE: (If so equipped)

Part of the optional Auto Fill & Chemical Feed system, the Filter & Foot Valve is on the end of the chemical feed hose that is placed in the chemical jug as part of the chemical feed system. Regularly examine the filter and clean as needed.

To test the Foot Valve:

- Remove the Filter & Foot Valve from the end of the chemical feed hose and rinse in fresh water.
- Blow through the valve from the filter side of the barb.
  - If the Foot Valve is functioning, air should move freely from the filter side, but will not flow from the barb side of the filter.
  - If valve is not functional, clean or replace as needed.

Heavy chemical build-up can be removed with a mild acid rinse and/or the use of a brush and compressed air.

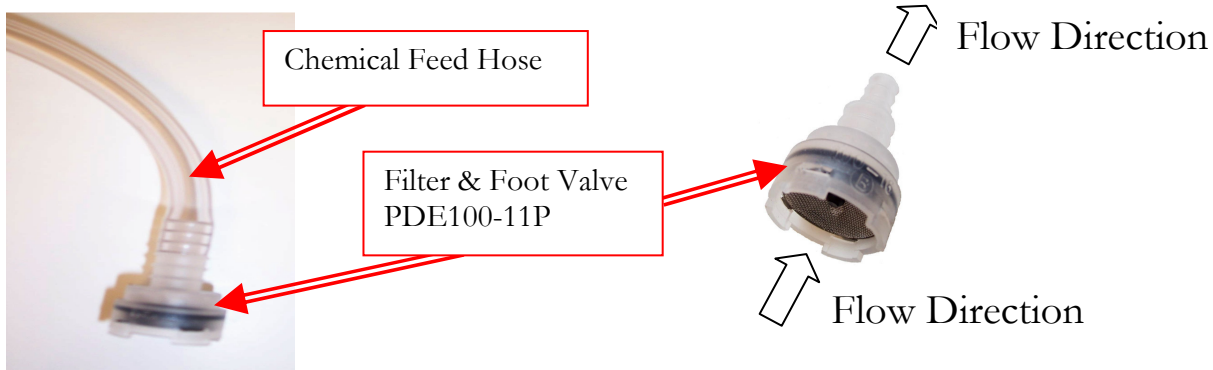

# CLEAN VACUUM SHUTOFF ASSEMBLY SCREEN:

Inside the recovery tank, on top of the stand pipe, is the Vacuum Shutoff Assembly. It functions to prevent debris and water from being sucked into the vacuum motors. Operating the MX200 without the Vacuum Shutoff Assembly or with a poorly maintained assembly will greatly decrease the life of the vacuum motors and will void the warranty.

If debris builds up on this filter, it will reduce the vacuum air flow and may cause a significant decrease in the rate of water recovery. If debris prevents the float from moving or seating against the Filter Cap Assembly, it may not stop the airflow when the tank fill with water, and the water will be sucked into the vacuums and blown out the exhaust.

**Use defoamer to prevent foam or moisture from entering vacuums (See Page 15).**

To clean:

- **Do not pull up on top of cap.** Carefully pull up from the bottom of filter cap assembly to pull the assembly off of the stand pipe. Then pull float off of riser pipe.
- Pull fibers and lint off and rinse filter cap assembly and float with clean water.
- Place the float back on the riser pipe then push the filter cap assembly back onto the stand pipe and replace the recovery tank lid.

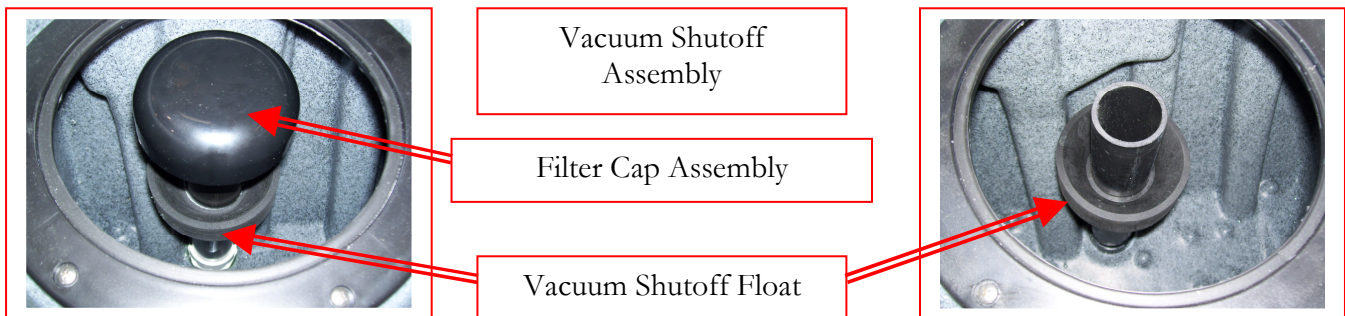



## CLEAN THE HYDRO-FILTER II: (If so equipped)

When used with the MX200, build-up of debris in the filter screen of the optional Hydro-Filter II will reduce the vacuum air flow and may cause a significant decrease in water recovery. A torn filter screen will allow debris past the filter and into the recovery tank. This debris can clog the Waste Pump and the Vacuum Shutoff Assembly. **The Hydro-Filter II must be examined and cleaned regularly to keep the MX200 functioning properly:**

- Grasp and turn the lid counterclockwise to open the Hydro-Filter II lid.
- Remove the filter screen. Examine the screen and clean or replace as needed.
- Rinse the body of the Hydro-Filter II with clean water.
- Examine the o-ring lid seal and replace as needed.
- Re-install the new or cleaned screen.
- Screw the lid back onto the body and turn clockwise to tighten.



## RINSE OUT RECOVERY TANK:

Build-up of fine silt, sand and other debris in the recovery tank can damage the Drain Valve (and Waste Pump if so equipped). Hair and fibers in the recovery tank can clog the vacuum filter (and Pump-out filter if so equipped). Clean out the tank on a regular basis to extend the life of these components and to keep the tank and machine smelling better.

- Remove the recovery tank lid and open the drain valve.
- Place a bucket under the drain valve.
- Use a hose to rinse the dirt and debris out of the recovery tank.
- Close the drain valve and spray the tank with a deodorizer or disinfectant.
- Proceed to Waste Pump Cleaning and replace the recovery tank lid.
- Dispose of the dirty water and debris.



## CLEAN WASTE PUMP-OUT PUMP: (If so equipped)

Build-up of fine silt inside the optional Waste Pump can clog the pump even if the pump is not used, so this maintenance procedure should be performed regardless of whether the Waste Pump has been used.

- After cleaning out the recovery tank, remove the cap and connect the Pump-Out hose to the Waste Pump outlet fitting on the back of the machine; run the hose to a drain.
- Remove the waste pump filter screen by turning it counterclockwise. Remove the filter screen. Examine the screen and clean or replace as needed.
- Re-install the filter screen. Thread the filter loosely on to the nipple – Leave slightly loose to keep it easier to remove for future cleaning.
- Use a hose to fill the recovery tank approximately 1/2 full with clean water.
- With Cord (Cord #1 unheated units or Cord #2 heated units.) plugged in, turn the Waste Pump switch to the ON position.
- Let the pump run until it pumps the level down to the point below the pump intake filter.
- Unplug the cord and turn the Waste Pump switch OFF.
- Open the drain valve and drain out the remaining water.
- Close the drain valve, replace the recovery tank lid, and dispose of the dirty water and debris.



## FLUSH SOLUTION TANK AND PUMP:

- Pour two or three gallons of clean water into the solution tank.
- With Cords #1 & #2 plugged in, connect the pump prime hose to the solution outlet female quick connect.
- Direct the end of the pump priming hose into the recovery tank vacuum barb.
- Turn one or both of the vacuums ON and turn the solution pump ON.
- Let the pump run until most of the water has been pumped out of the solution tank.

**NOTICE** Do not let the pump run dry. Turn the pump OFF before the water gets to the bottom of the tank.

- Turn the vacuums OFF and disconnect the prime hose.
- Place a bucket under the drain valve; open the drain valve to drain the water out of the recovery tank.
- Close the drain valve and dispose of the water.



Pour 2 or 3 gallons of clean water into Solution Tank

If there is a heavy chemical build-up in the machine, hoses, or tools, a mild acid can be added to the rinse water in the previous procedure (REFER TO PHOTOS ON FOLLOWING PAGE.)

- After the pump has been primed, turn the solution pump switch OFF and turn the vacuums OFF.
- Remove the pump priming hose and connect the solution hose and tools.
  - Turn the solution pump ON and direct the tool spray into a bucket. Let the pump run until most of the water has been pumped out of the solution tank.

**NOTICE** Do not let the pump run dry.  
Turn the pump OFF before the water gets to the bottom of the tank.

## FLUSH SOLUTION TANK AND PUMP: (continued from previous page)

- Disconnect the solution hose and tool.
- Use the vacuum hose to vacuum the remaining acid solution out of the solution tank.
- Pour two or three gallons of clean water into the solution tank.
- Connect the pump prime hose to the solution outlet female quick connect.
- Direct the end of the prime hose into the recovery tank vacuum barb.
- Turn one or both of the vacuums ON and turn the solution pump ON. Let the pump run until most of the water has been pumped out of the solution tank.

### NOTICE

**Do not let the pump run dry. Turn the pump OFF before the water gets to the bottom of the tank.**

- Turn the vacuums OFF and disconnect the prime hose.
- Place a bucket under the drain valve and open the drain valve to drain the water out of the recovery tank.
- Close the drain valve and dispose of the water.



Vacuum acid solution out of Solution Tank



Drain Recovery Tank

## CLEAN PUMP INLET FILTER

A restricted Pump Inlet Filter can prevent the solution pump from providing adequate pressure for cleaning. A restriction or air leak on the pump inlet hose can also damage the solution pump check valves and plunger seals.

- To examine the filter, open the solution tank lid on the front of the machine. The filter is in the bottom of the solution tank.
- Grasp the filter cap and unscrew the filter from the brass nipple by turning counter-clockwise. Clean or replace the filter as needed (PP14-806504).

**⚠ WARNING** Before proceeding with this procedure, drain the solution tank & recovery tank. Make sure both power cords are disconnected.

- To examine the pump inlet hose, release the latches on the front/bottom of the machine and tilt the tanks off of the base assembly.
- Examine the hose for kinks, clogs or holes and repair or replace the hose as needed. (Replacement Hose: NM5086 – sold per foot)
- Tilt the tanks back onto the base and secure the latches.

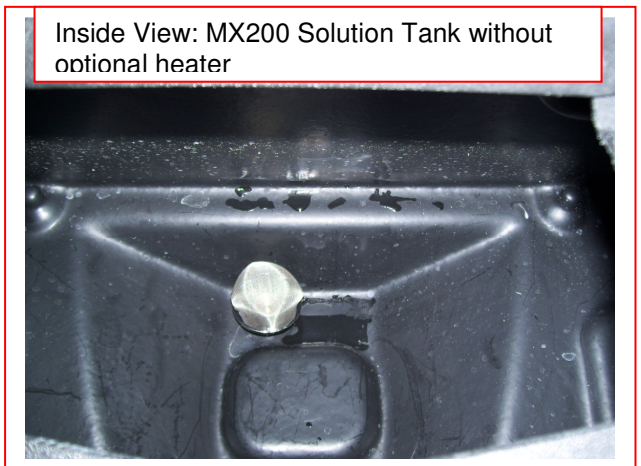

SOLUTION FILTER  
PP14-806504





## FLUSH CHEMICAL SYSTEM: (If so equipped)

Chemical build-up in the optional Auto Fill chemical system can prevent the system from drawing chemical.

- Rinse the chemical system with fresh water (For heavy chemical build-up, a mild acid can be added to the rinse water.)
- Remove the chemical feed hose from the solution tank and place the end of the hose in a bucket of fresh water or mild acid solution.
- Connect the Auto-Fill Water Supply Hose to the water inlet (male quick connect) on the front of the machine.
- Connect the other end of the hose to a water faucet and turn on the water. Let the water flow into the tank until you are sure the rinse solution has been drawn through the proportioner and mixed with the incoming water. The metering tip can be removed from the proportioner to speed up the process.
- Once the rinse solution has been drawn through the proportioner, turn off the water faucet and disconnect the Auto-Fill Water Supply Hose.
- Plug in Cord #1, connect the vacuum hose to the vacuum barb, turn on one or both vacuums, and use the vacuum hose to remove the water from the solution tank.
- When the solution tank has been emptied, turn off the vacuums and unplug the power cord.
- Place a bucket under the drain valve and open the drain valve to drain the water from the recovery tank.
- Close the drain valve and dispose of the water.

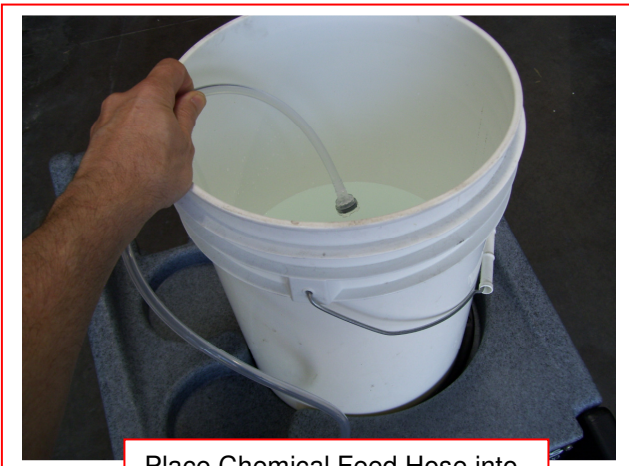

Place Chemical Feed Hose into Rinse Solution

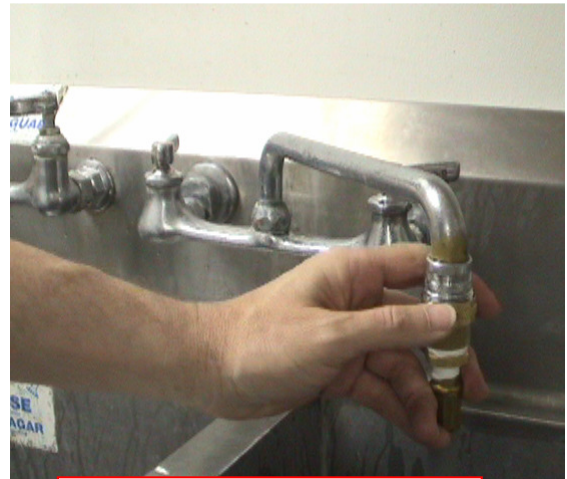

Connect Auto-Fill Water Supply Hose to machine and faucet



Vacuum water out of Solution Tank



Drain water from Recovery Tank



# CLEAN RECOVERY TANK DRAIN

Debris and sand accumulation in the drain valve can damage the valve or prevent it from closing completely. This will result in dirty water leaking from the valve. Use of the Hydro-Filter and regular cleaning of the recovery tank will help prevent this, but occasionally the drain valve will require cleaning or replacement.

## **⚠ WARNING**

**Unplug power cord and drain the recovery tank before attempting to service the drain valve.**

- Unscrew the nuts and remove the four bolts holding the valve assembly to the flange attached to the recovery tank. Unless the flange is damaged, it does not have to be removed from the tank, even when replacing the drain valve.
- Separate the valve body, outlet adapter and gaskets from the flange.



Remove four bolts holding valve assembly to flange fitting

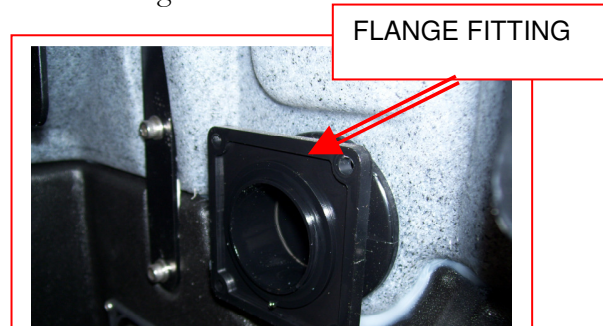

Unless damaged or leaking between tank and flange, the flange fitting does not have to be removed



DRAIN VALVE – PEA11

VALVE BODY

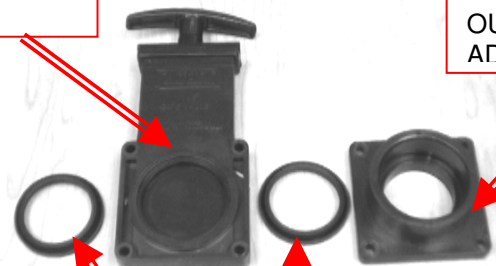

OUTLET ADAPTER

GASKET – NM3019

- Examine the valve body for wear. Check the valve slide for deep scratches. Deep scratches will allow water to flow past gaskets and leak from valve. Replace valve if needed.
- Examine the gaskets and replace if cut, torn or deformed.
- Raised, rounded side of gasket goes toward valve slide. Larger flat sides seat on ring on flange and outlet adapter. Sand and debris will collect in the bottom of the valve body and prevent the slide from going down and seating properly.
- Clean debris out as needed so slide can move to bottom.
- Rinse valve body and reassemble valve body, gaskets and outlet adapter, and place assembly back onto flange fitting.
- Replace four bolts and tighten evenly to secure assembly to flange. Do not over-tighten bolts.



Clean debris from slot in bottom of valve body. Valve slide must be able to slide to bottom.

## Storage Prep and Freeze Protection Procedures:

Your Nautilus MX200 must be protected from freezing. Freezing can cause serious damage to the pump, pump-out, auto-fill float valve, and any other component containing water. If the MX200 is transported or stored in freezing temperatures, the following procedures should be performed.

ALSO, if the MX200 is stored for an extended period of time, the following procedure should be performed to prevent the pump seals from drying out.

1. In a separate container mix 1/2 gallon of water with 1/2 gallon of automotive radiator Ethylene Glycol anti-freeze. (Propylene glycol can be used as a non-toxic alternative anti-freeze.). Mix well and pour into the solution tank.
2. Connect the solution hose to the solution outlet (female quick connect).
3. **If not equipped with the optional Auto Fill System**, snap an open quick connect onto the other end of the hose and place the hose end back into the solution tank.  
**If equipped with the Auto Fill system**, connect the opposite end of the HP solution hose to the Auto-Fill inlet (male quick connect.) Leave the chemical feed hose in the solution tank and ensure the check valve filter is submerged in the anti-freeze solution. To speed the process the metering tip can be removed.
4. Turn the solution pump switch to the ON position and perform the pump priming procedure. When the pump is primed, allow the anti-freeze to circulate for 5-10 minutes. Mix and add more anti-freeze solution as needed. For machines with the optional Auto Fill System, make sure end of chemical feed hose stays submerged in the anti-freeze solution. This will assure that the anti-freeze will be drawn into the proportioning valve.
5. Connect any cleaning tools and solution hoses that will be stored with the MX3-200. Direct tool spray back into the solution tank or into a bucket. Repeat for all tools to be protected.
6. Turn the solution pump switch to the OFF position.
7. Use the vacuum hose to vacuum the remaining anti-freeze solution out of the solution tank and bucket.
8. If so equipped, remove the cap from the waste-pump out outlet fitting on the back of the machine. Connect a hose to a drain or hold a bucket up to the fitting to catch the pump-out flow. Remove the lid from the recovery tank. Turn the Waste Pump switch to the ON position to engage the pump-out. Turn off the Waste Pump Switch as soon as you see anti-freeze flowing from the outlet fitting or hose.
9. Drain the remaining anti-freeze solution from the recovery tank and the machine is ready for storage.

## RETURNING THE MX200 TO SERVICE AFTER STORAGE OR FREEZE PROTECTION:

To return the MX200 to service, the anti-freeze must be flushed from the machine. Flush the anti-freeze out of the machine by repeating the procedures above using fresh water in place of anti-freeze.

**Section**  
**3**

**Parts**

*Replacement parts available for repair of your MX200.*

**MX200 PUMP – AP51**  
**PARTS ASSEMBLY**

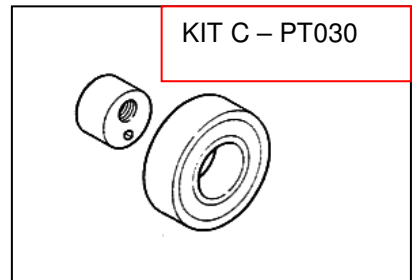
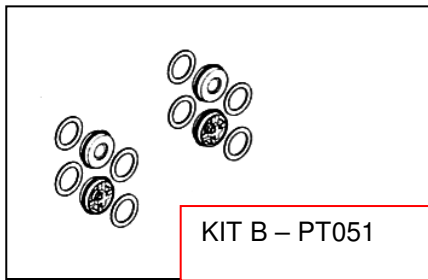
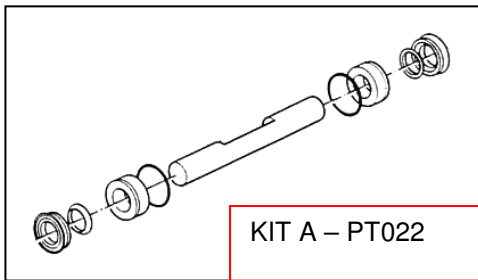
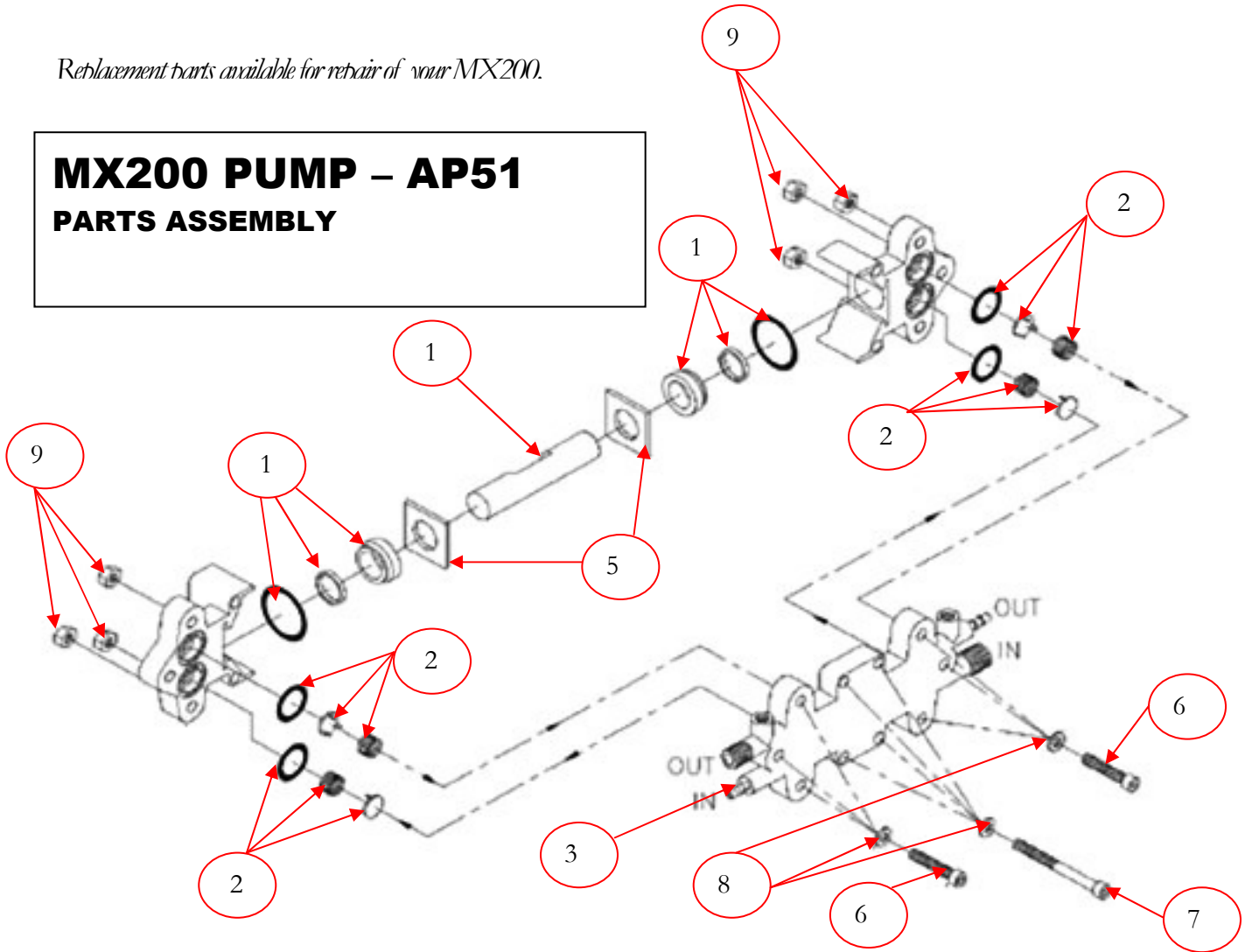

ITEM	DESCRIPTION	QTY	PART NUMBER
1	KIT A PLUNGER & SEALS	1	PT052
2	KIT B VALVES & O-RINGS	1	PT051
NS	KIT C CAM & BEARING	1	PT030
3	MANIFOLD 6-PORT	1	0114-0004-3110
4	PUMP HEAD	2	0114-0002-0111
5	RETAINER PLATE	2	0111-0014-0001
6	HEAD BOLT	6	BOLT-1/4-20X1 1/4-SHCS-SS
7	MOUNT BOLT	4	BOLT-1/4-20X2 1/2-SHCS-SS
8	WASHER FLAT M6 STAINLESS STEEL	10	WSH-FLAT-M6-SS
9	NUT 1/4-20 NYLOCK HEAD BOLT	6	NUT-1/4-20-NYLOCK-ZP
NS	PUMP COMPLETE WITH MOTOR	1	AP51
NS	PUMP WITHOUT MOTOR	1	PT047
NS	MOTOR	1	PT061

## PRESSURE REGULATOR – PT048

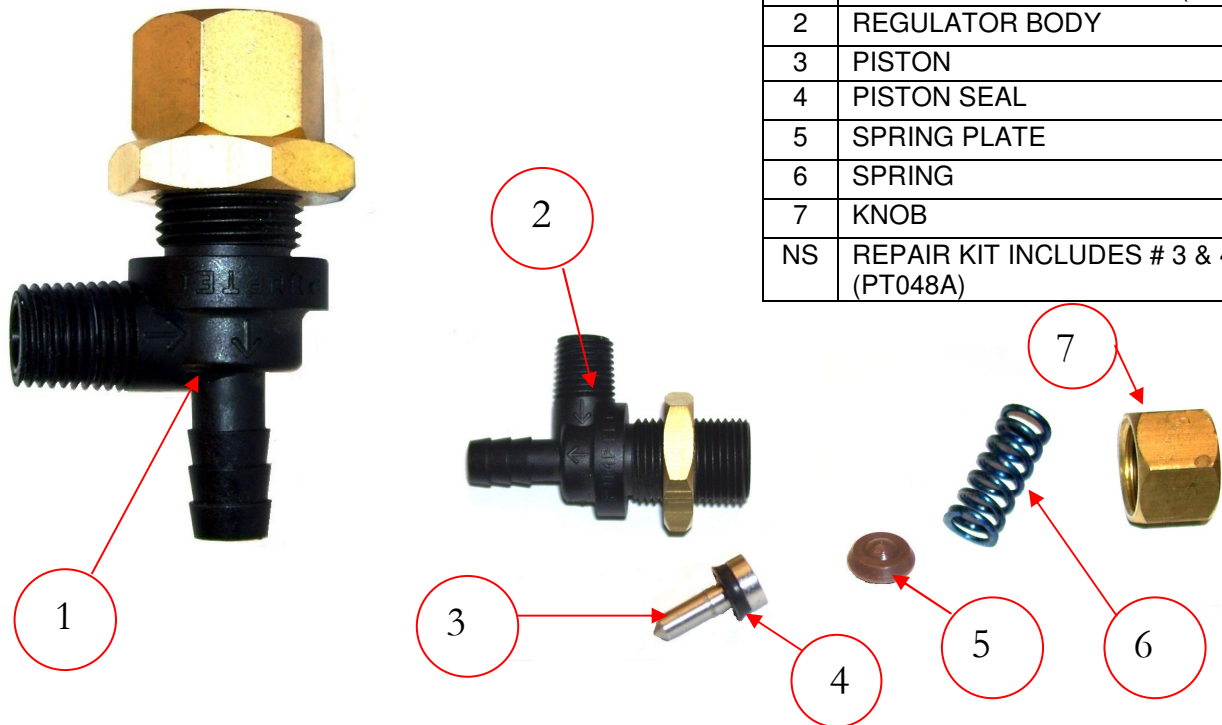

	DESCRIPTION
1	REGULATOR COMPLETE (PT048)
2	REGULATOR BODY
3	PISTON
4	PISTON SEAL
5	SPRING PLATE
6	SPRING
7	KNOB
NS	REPAIR KIT INCLUDES # 3 & 4 (PT048A)



**OPTIONAL AUTO-FILL ASSEMBLY – M013**

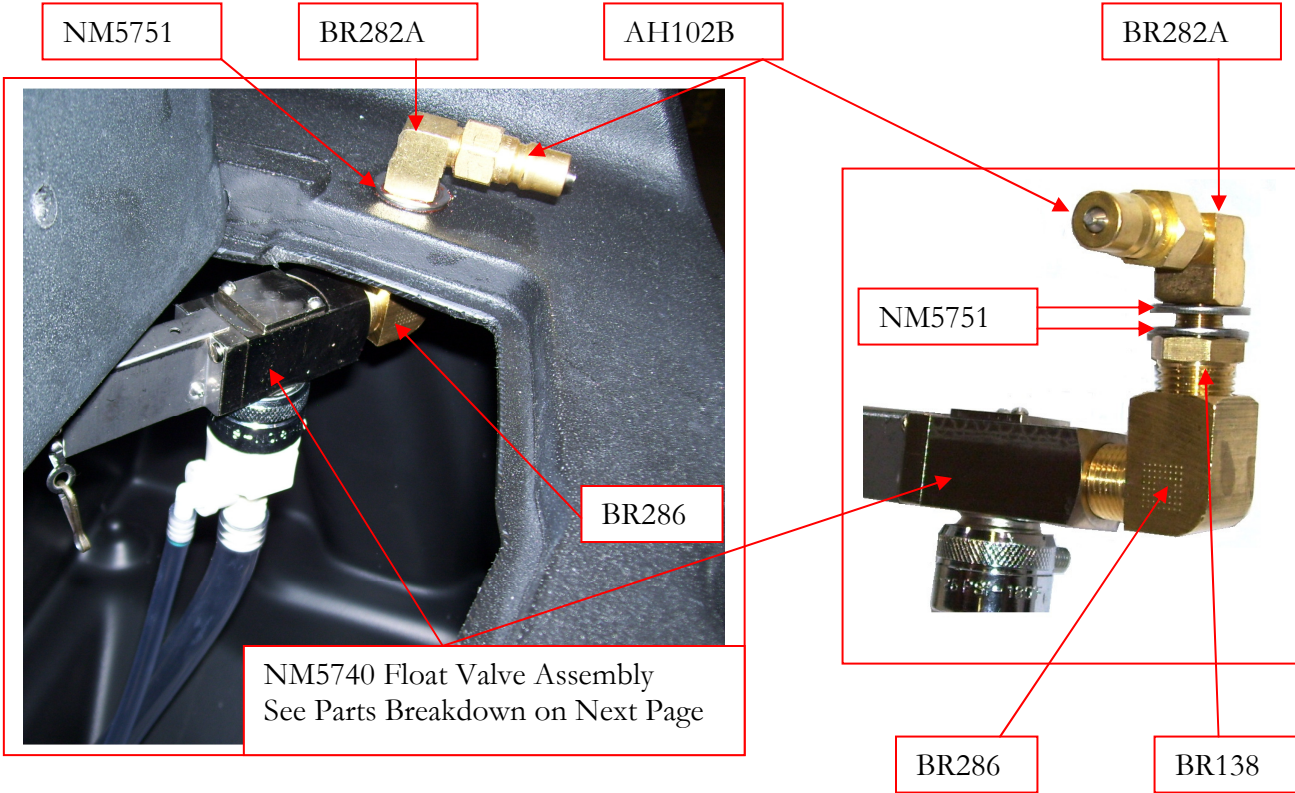

## OPTIONAL AUTO-FILL FLOAT VALVE ASSEMBLY NM5740

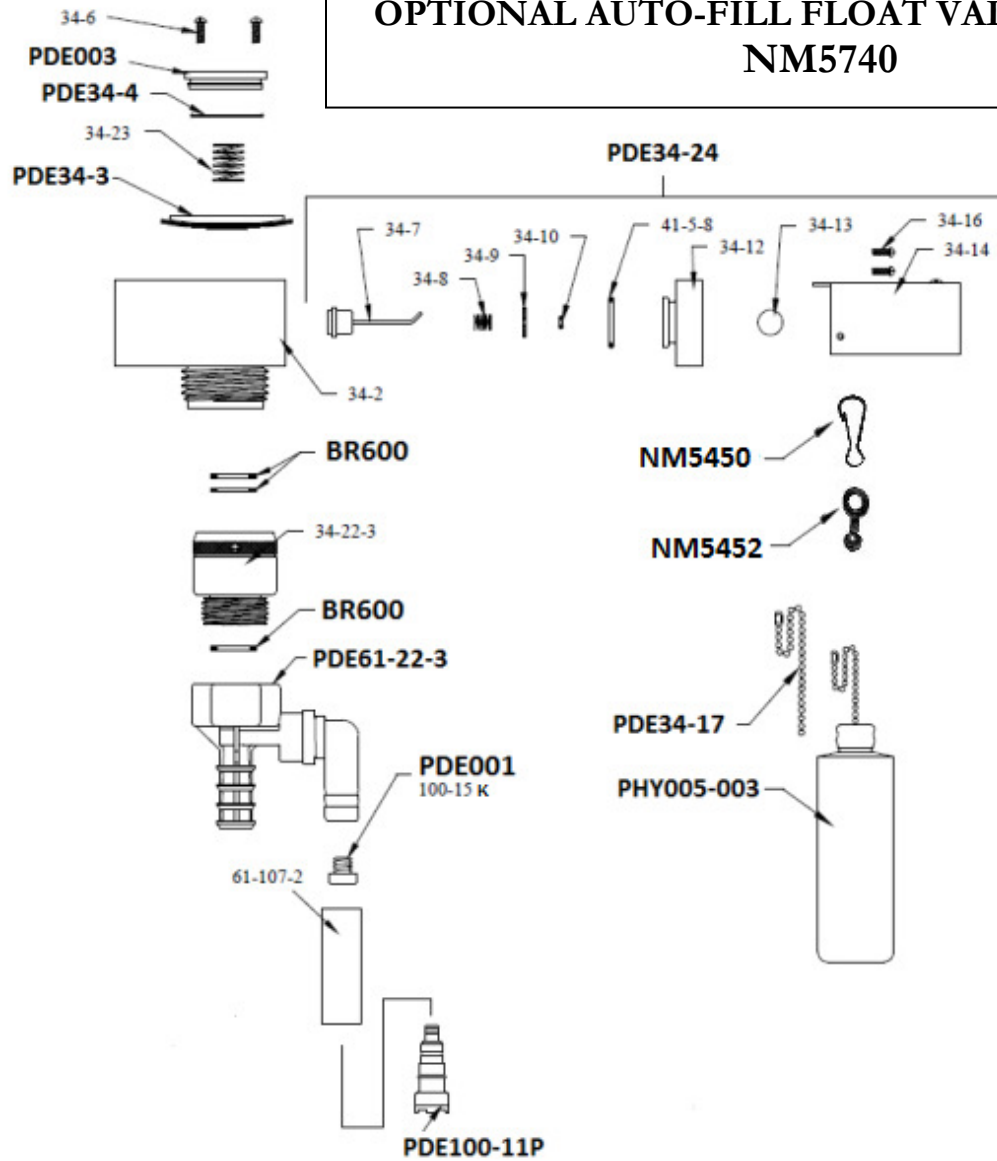

PART NO.	DESCRIPTION	PART NO.	DESCRIPTION
16-3	3' DISCHARGE TUBING	PHY005-003	FLOAT ASSEMBLY
34-1	INLET HOSE ADAPTER	PDE34-17	CHAIN WITH CONNECTOR
34-2	BODY ASSEMBLY	PDE61-22-3	PROPORTIONER ASSY
PDE34-3	DIAPHRAGM ASSEMBLY	61-107-2	CERAMIC WEIGHT
PDE34-4	VALVE COVER O-RING	NM5450	SNAP CLIP
PDE003	VALVE COVER	NM5452	CONNECTOR
34-6	VALVE COVER SCREWS (2)	BR600	RUBBER WASHER
34-7	PILOT VALVE DISC AND STEM ASSEMBLY	PDE001	METERING TIP KIT 14 TIPS
34-8	PILOT VALVE SPRING	100-15	METERING TIP SPECIFY SIZE
34-9	PILOT VALVE PLATE	100-12	8' PLASTIC SUPPLY TUBING 1/4" ID
34-10	PILOT VALVE STEM O-RING	PDE100-11P	FOOT VALVE
34-12	PILOT VALVE COVER		
34-13	STEM NUT WITH SET SCREW	AH102B	QUICK CONNECT 1/4" MALE
34-14	LEVER ASSEMBLY	BR282A	ELBOW 90DEG 1/4" STREET LONG PROFILE
34-16	LEVER ASSEMBLY SCREWS (2)	NM5751	WASHER 1/4" FLAT SS (2)
34-22-3	BACKFLOW PREVENTER	BR138	NIPPLE 1/2" X 1/4" HEX
34-23	CLOSING SPRING	BR286	ELBOW 90 DEG 1/2" STREET
PDE34-24	PILOT VALVE ASSEMBLY		
41-5-8	PILOT VALVE COVER O-RING	M013	NAUTILUS AUTO FILL KIT - COMPLETE

# Optional Pump-Out Pump

## AP37

### PARTS ASSEMBLY

#### AP37 PARTS LIST

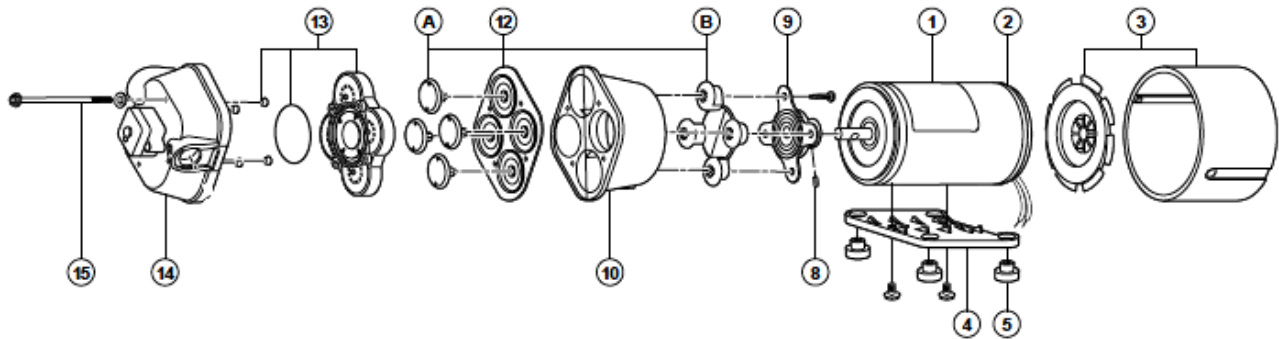

KEY PART NO.	DESCRIPTION	QTY	KEY PART NO.	DESCRIPTION	QTY
1	02009 -027A 15V AC Mtr	1	13	20407-020 Viton® Check Valve Kit w/"O" Ring & Ferrules	1
2	20115-113 Brush Endbell/Rect. Assy. (AC) w/BRG	1	14	20404-017 Upper Housing Assy Kit V/G SW45	1
3	20132-005 Fan/Shroud Kit	1	15	20405-000 Pump Screw Kit w/Washer & Ferrules	1
4	11028-101 Plastic Baseplate Assy. with Grommet & Screws	1	20381-010	3/4" Port Kit EPOM 90 DEG ELBOW	2
5	20132-000 Grommet Kit	Set of 4			
8	20552-000 Cam/Bearing Set Screw	1			
9	Cam/Bearing Kit w/Set Screw	1			
	20400-003	1			
10	20401-000 Bearing Cover P.P.	1			
12	20403-040 Diaphragm Kit w/Pistons & Screws Santoprene®	1			



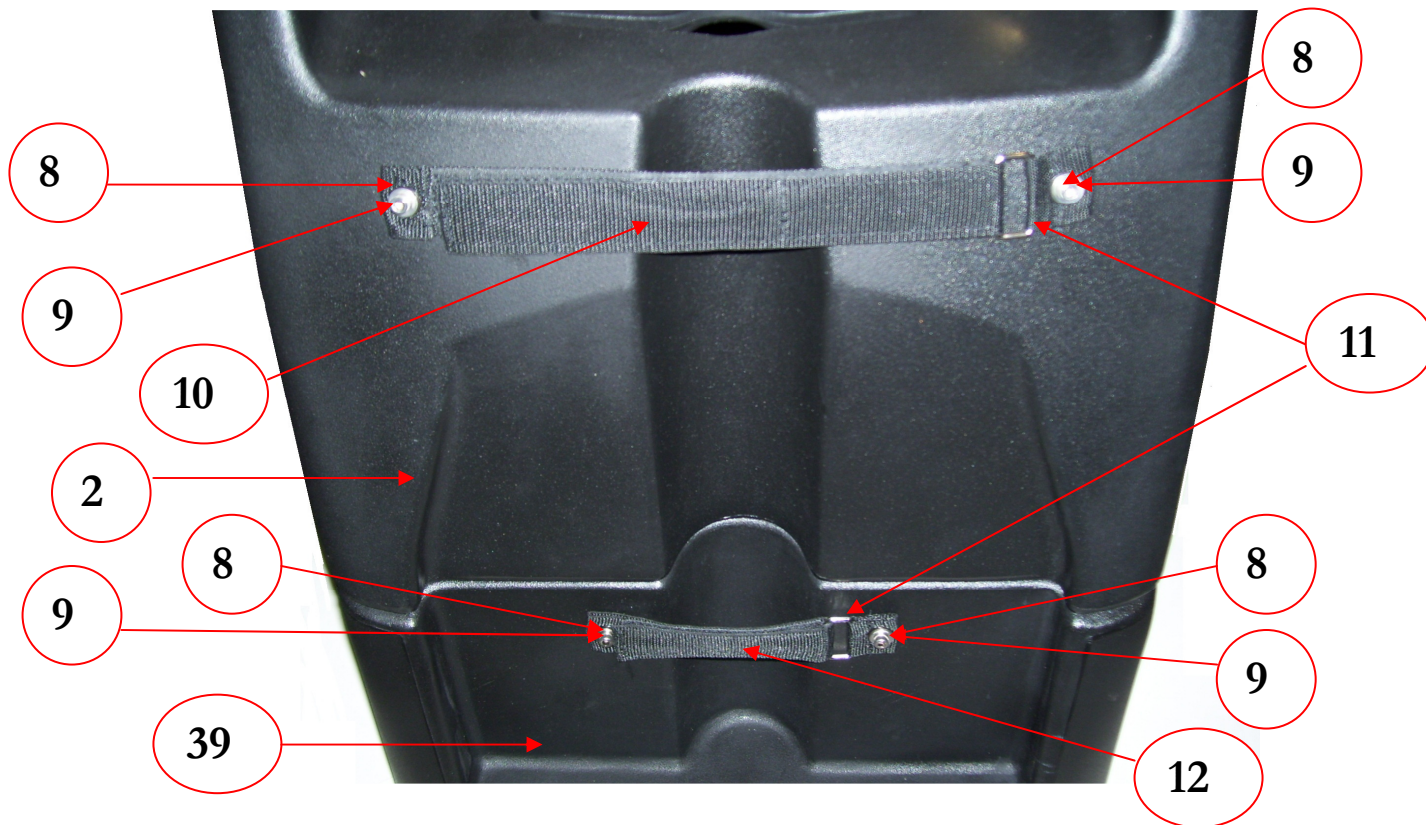
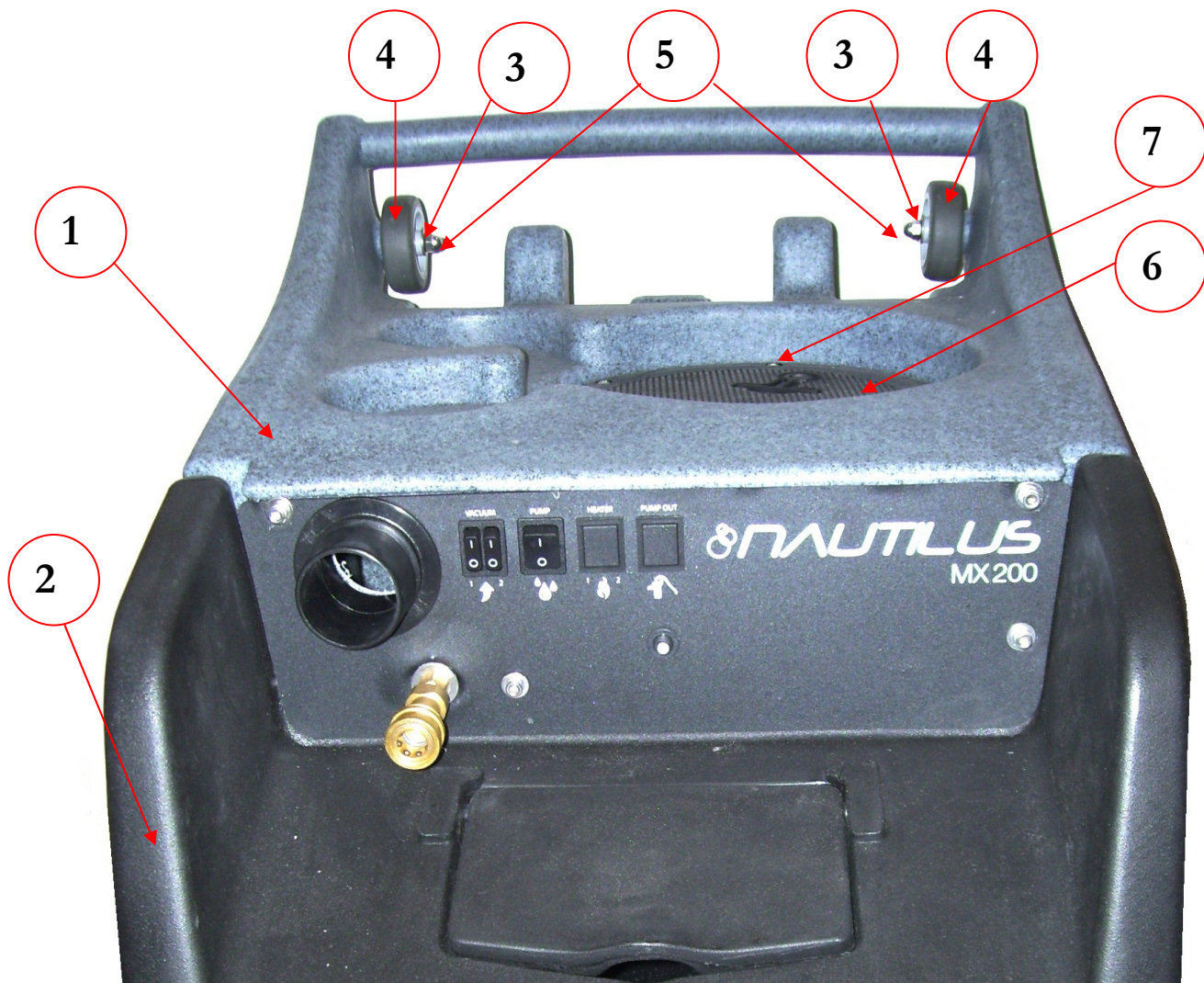



CONTROL PANEL

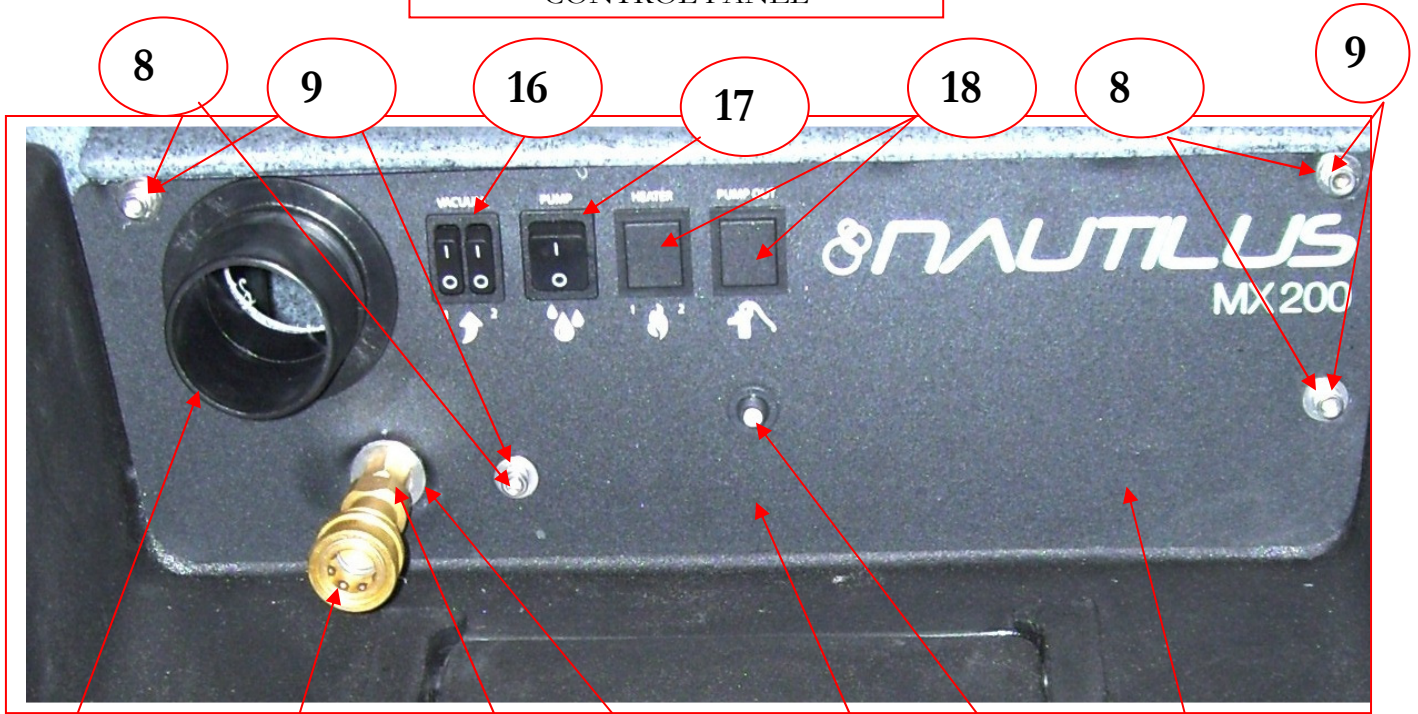

REAR VIEW - BASE & BASE SKIRT



HINGE SCREWS

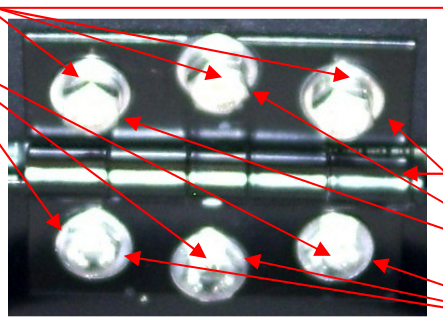



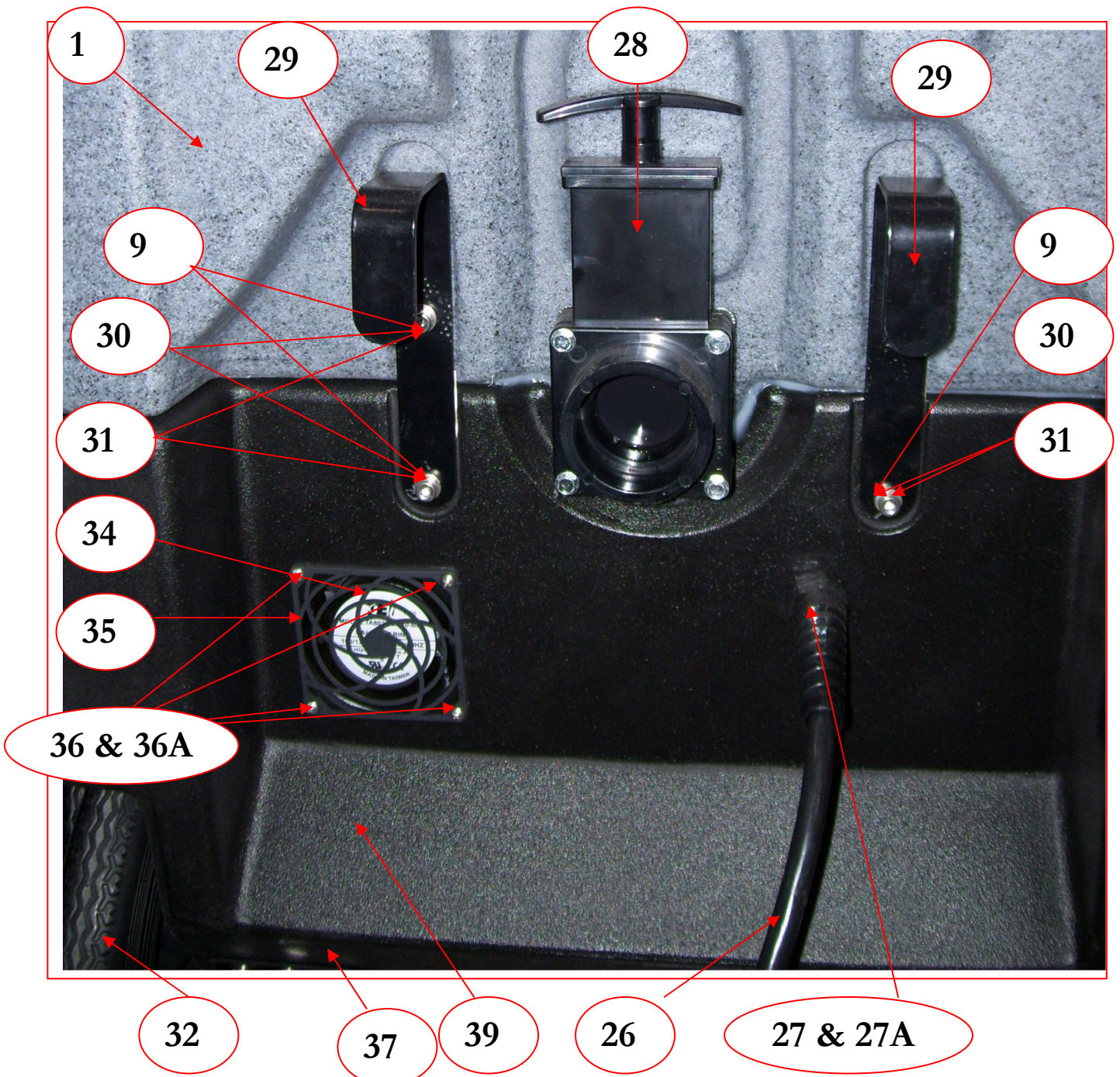

REAR VIEW – BASE, BASE SKIRT & RECOVERY TANK

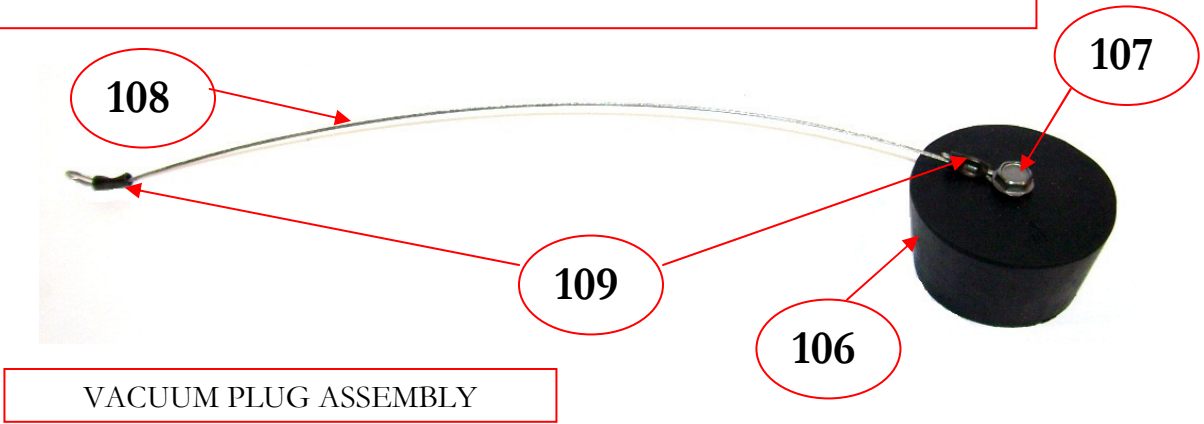

VACUUM PLUG ASSEMBLY



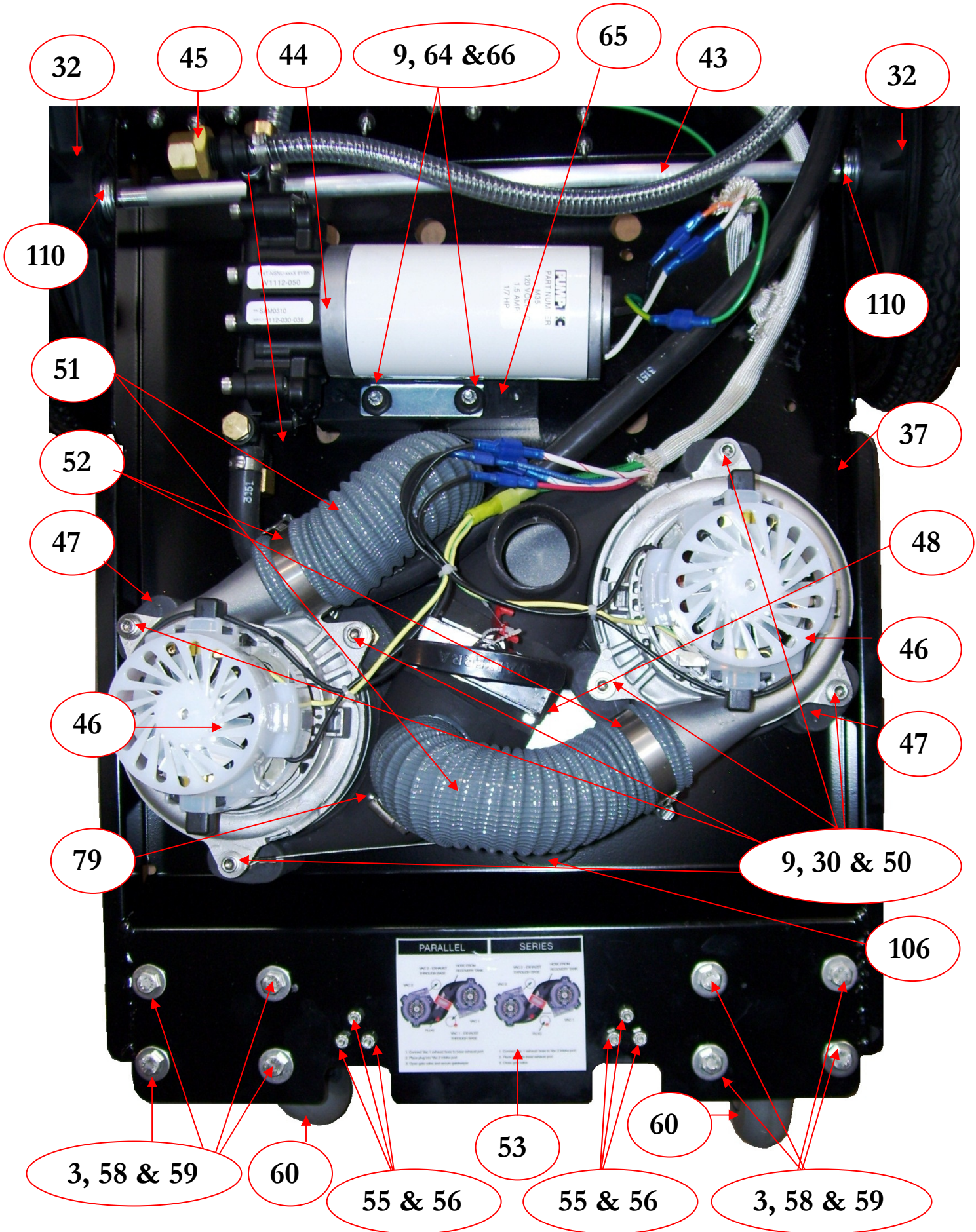

TOP VIEW OF BASE



VACUUM MOUNTS & CONNECTIONS

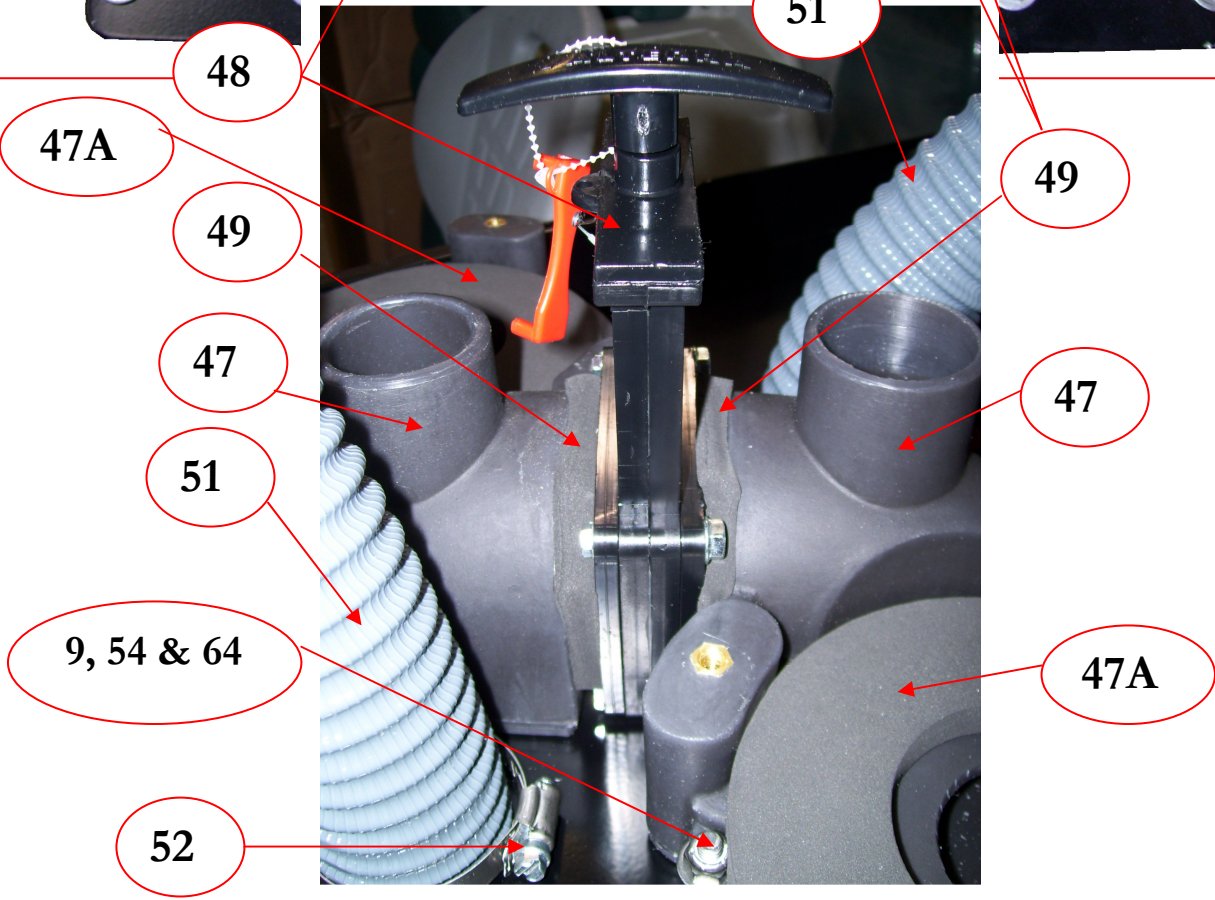
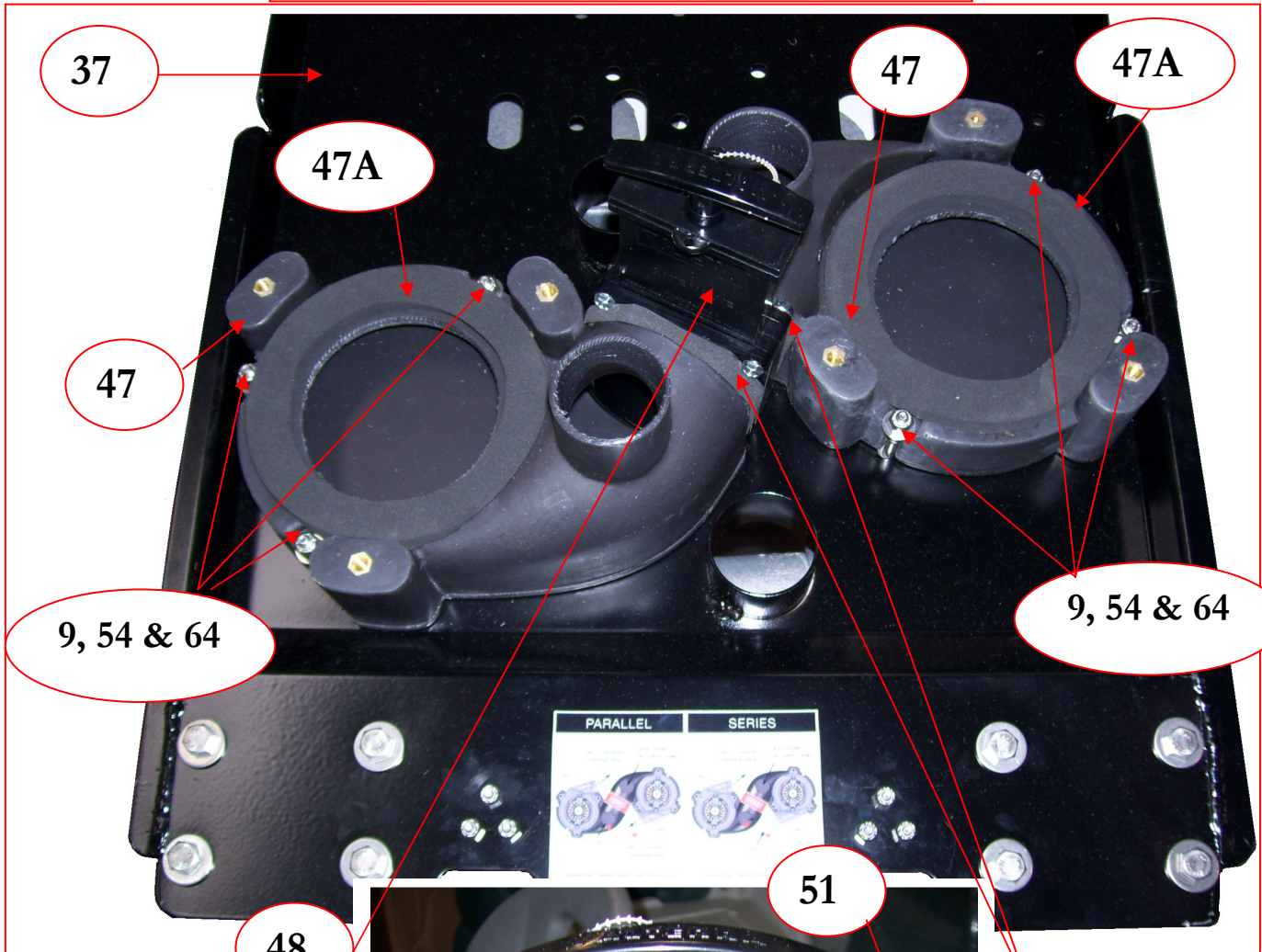



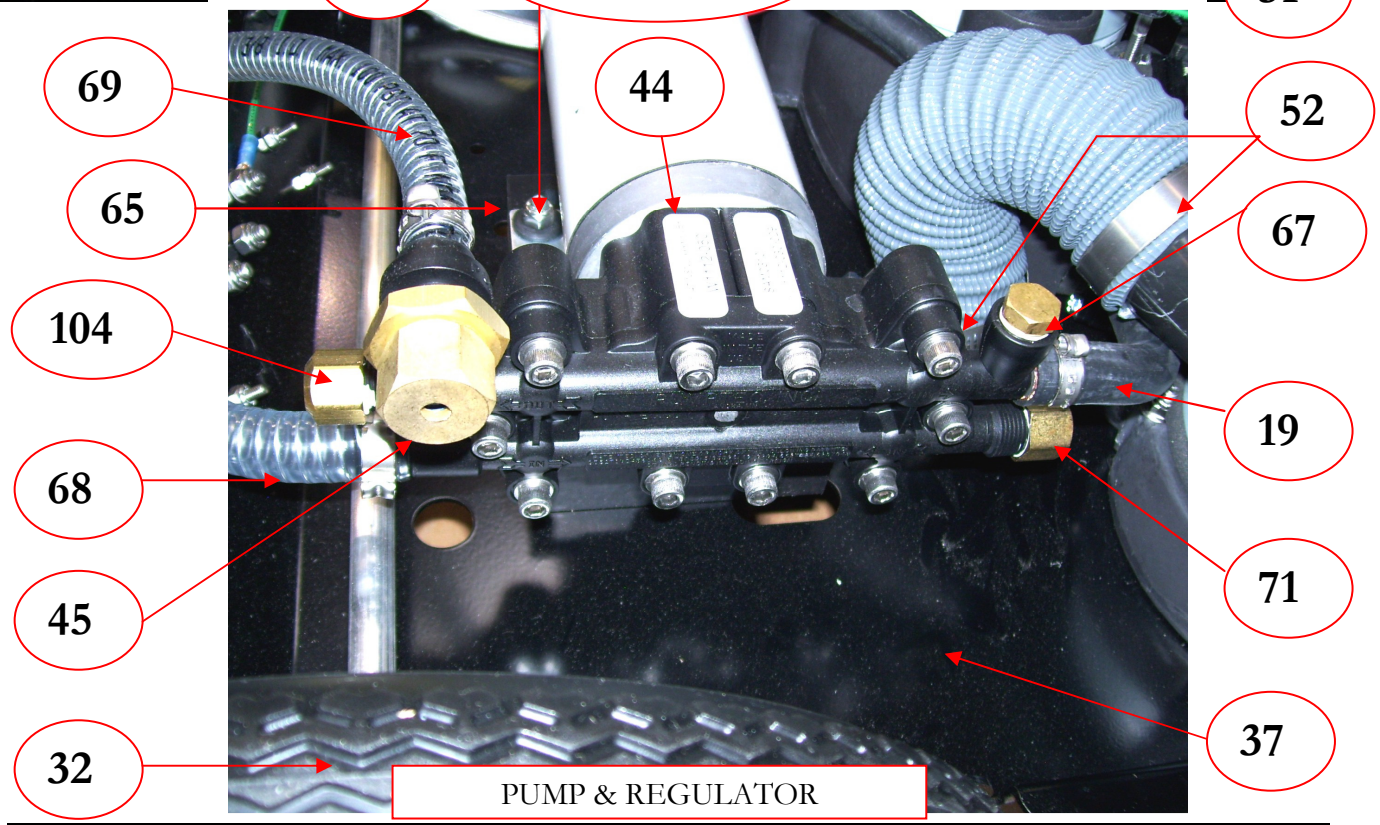
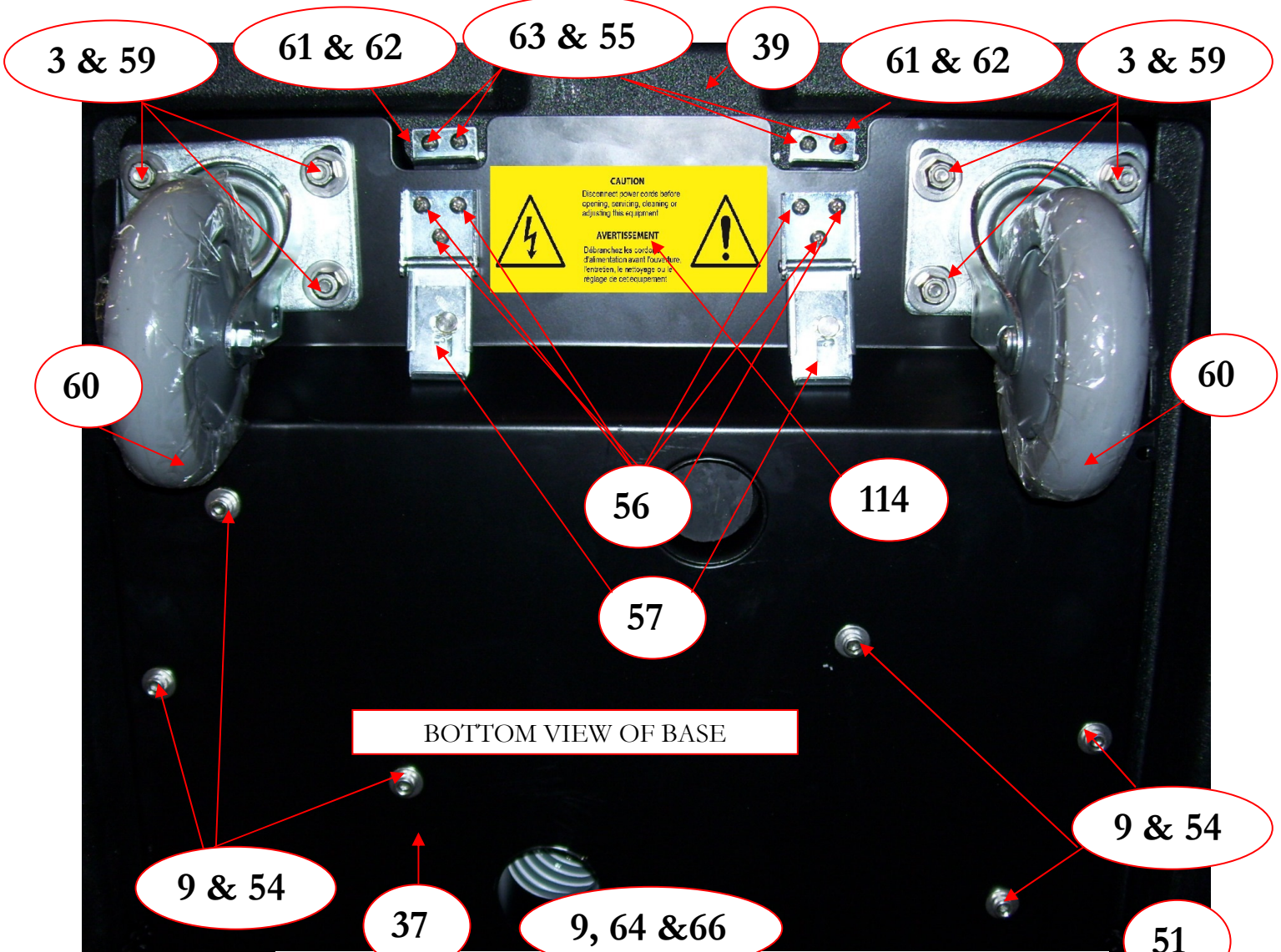



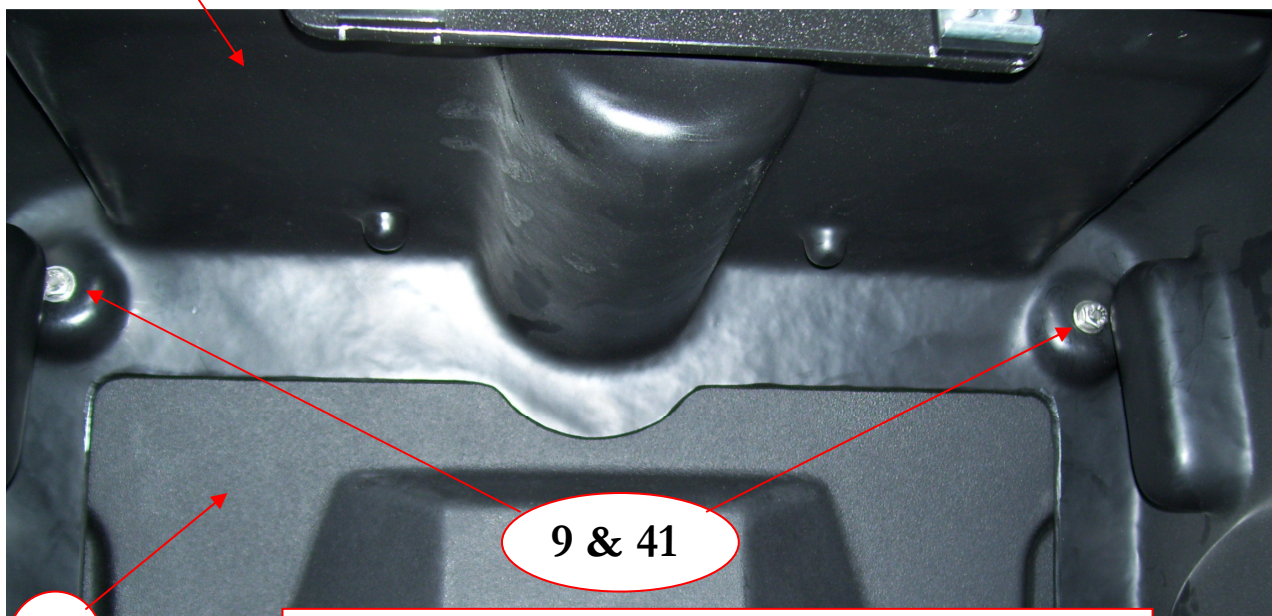
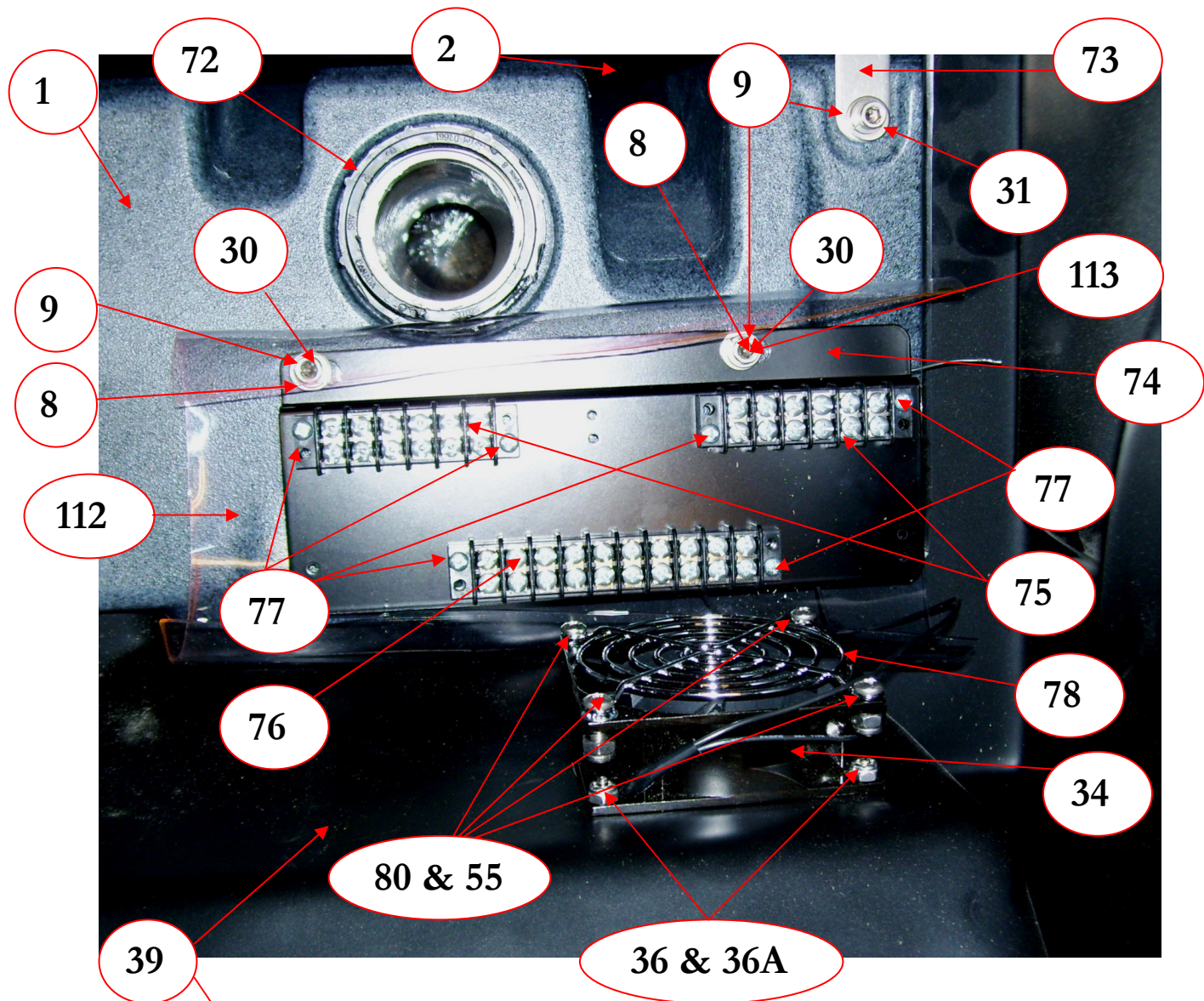

BOTTOM VIEW SOLUTION TANK & BASE SKIRT



39

2

BOTTOM VIEW SOLUTION TANK

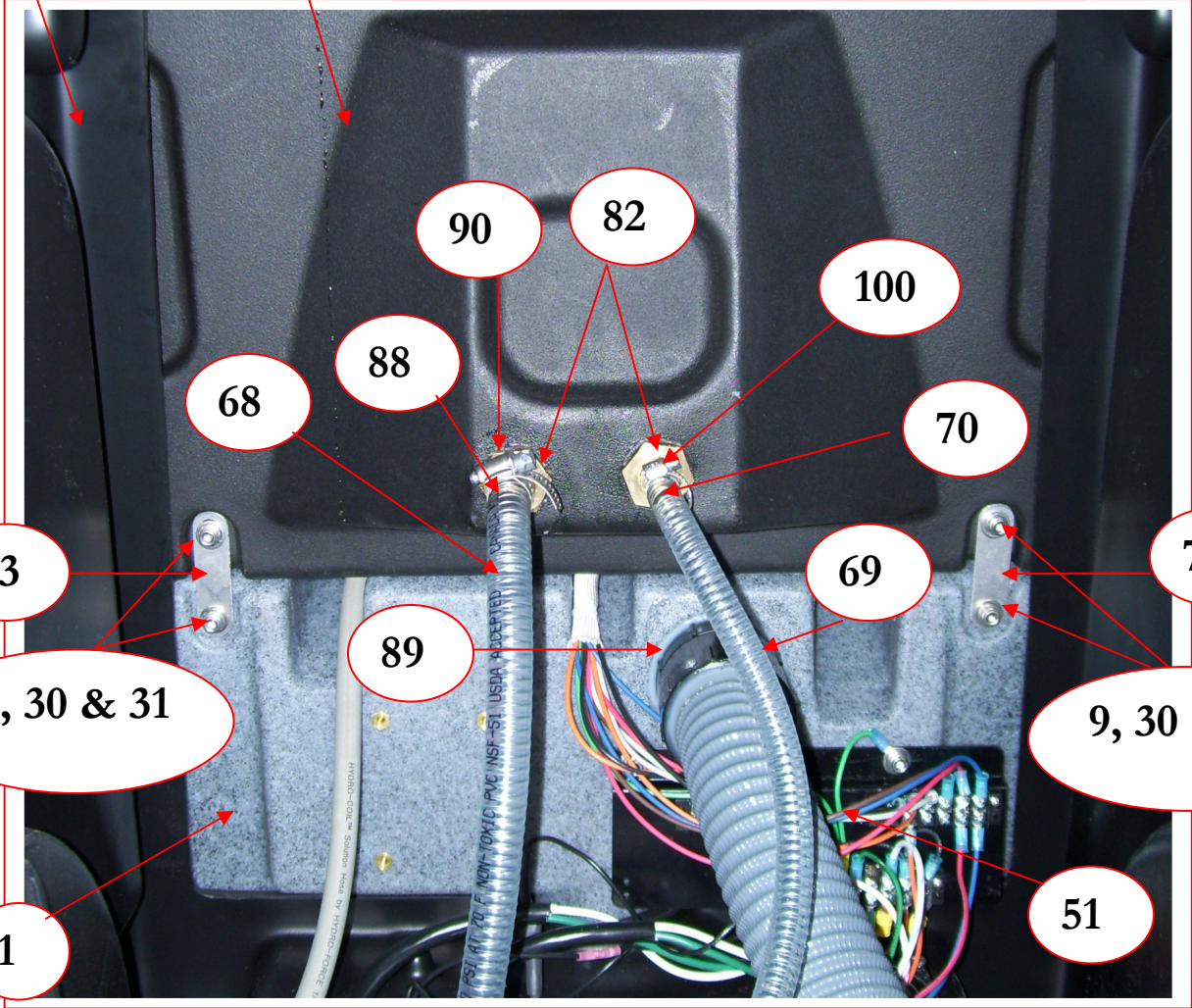

73

68

88

90

82

100

70

73

9, 30 & 31

89

69

9, 30 & 31

1

51

84

83

2

82

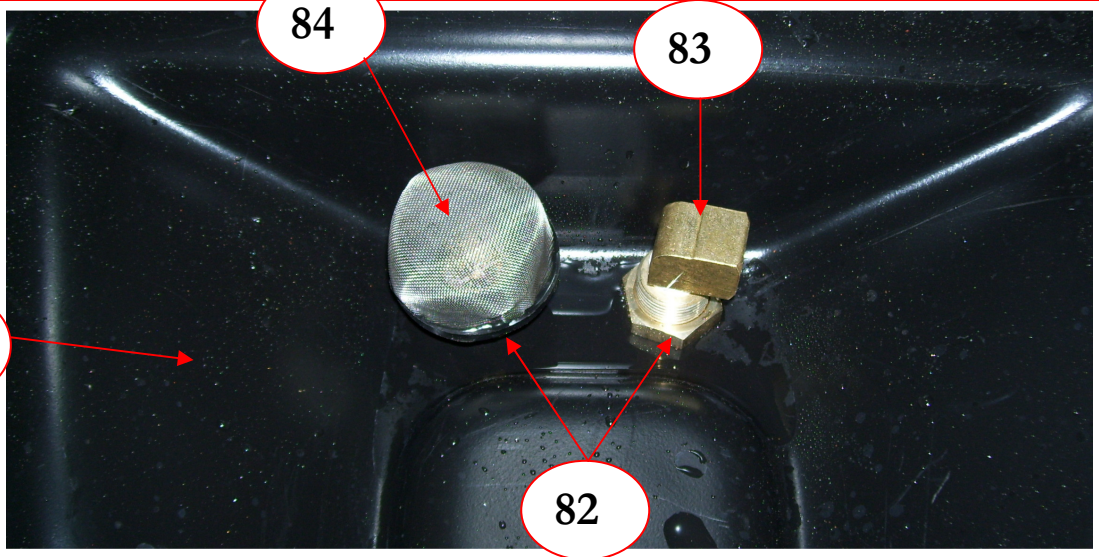

INSIDE SOLUTION TANK



INSIDE RECOVERY TANK  
VACUUM SHUTOFF AND OPTIONAL PUMP-OUT  
FILTER REMOVED

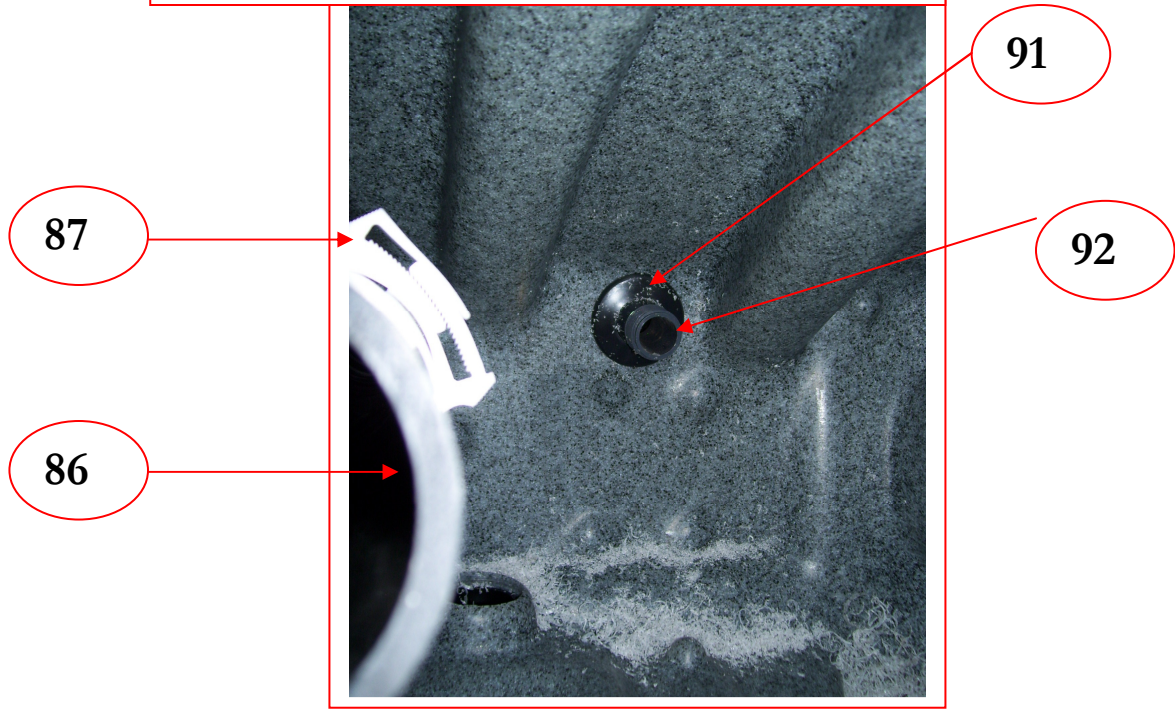

INSIDE RECOVERY TANK  
WITH OPTIONAL PUMP-OUT  
FILTER IN PLACE

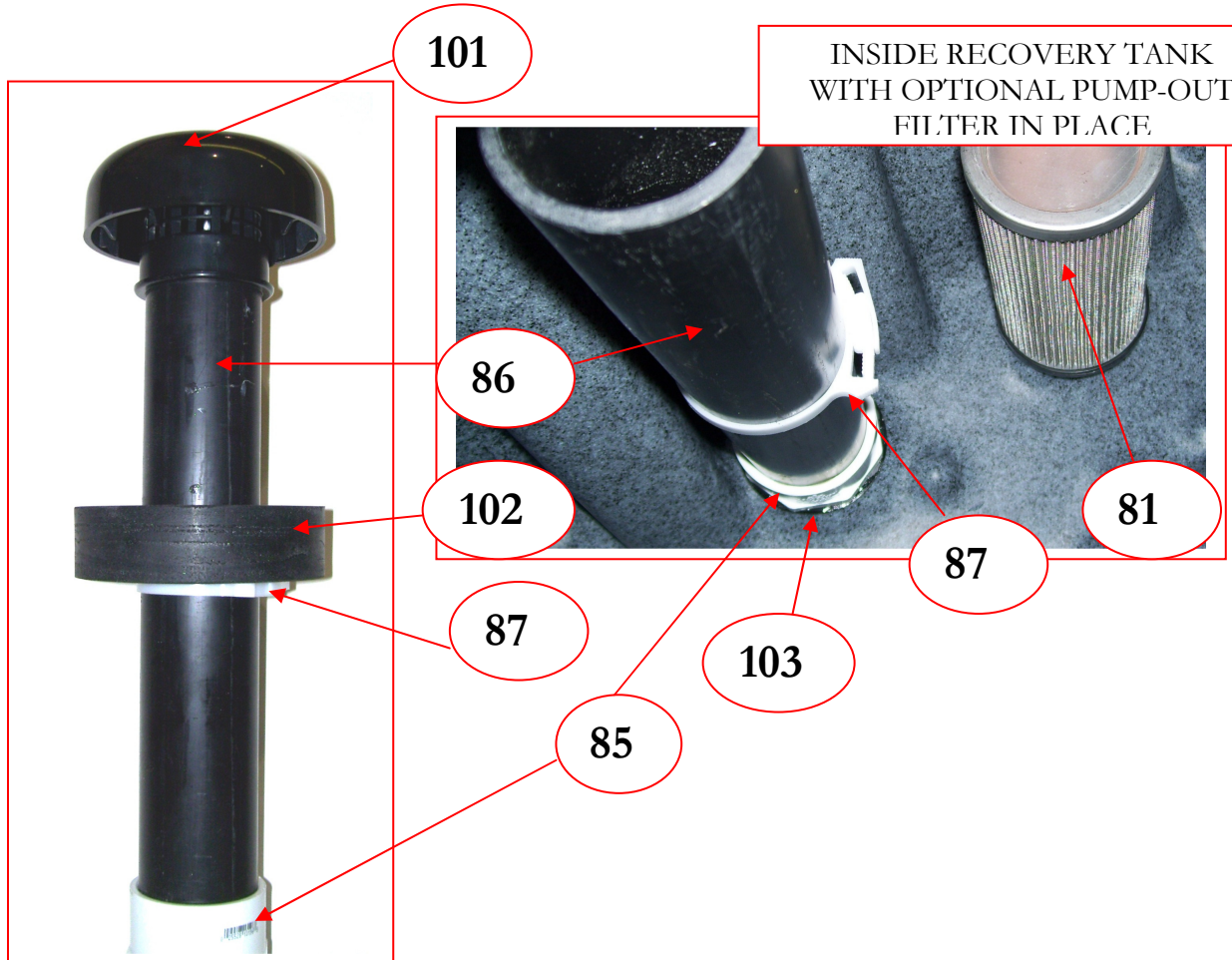

VACUUM SHUTOFF ASSEMBLY



OPTIONAL - PUMP-OUT CONNECTIONS

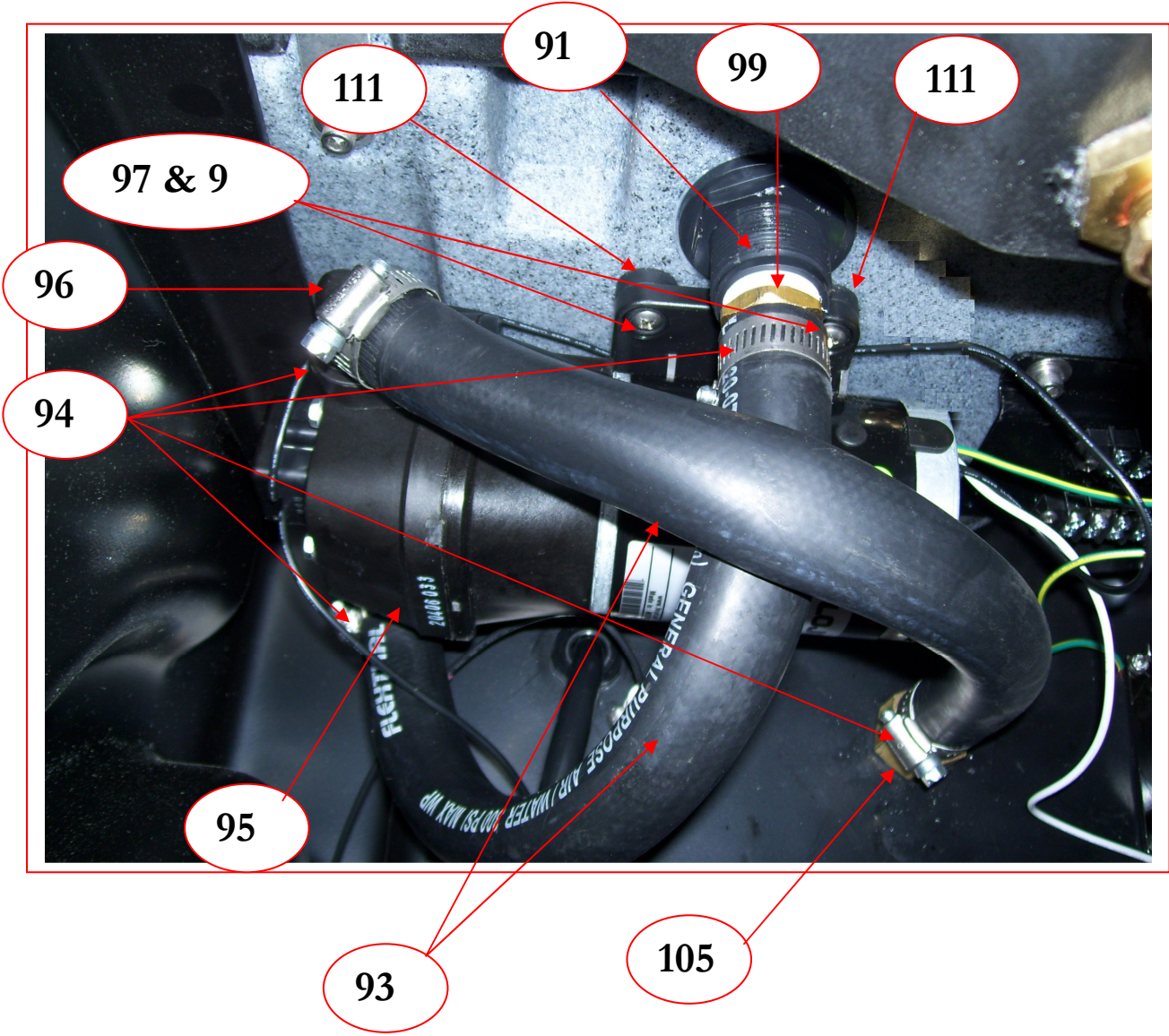

OPTIONAL PUMP-OUT PARTS

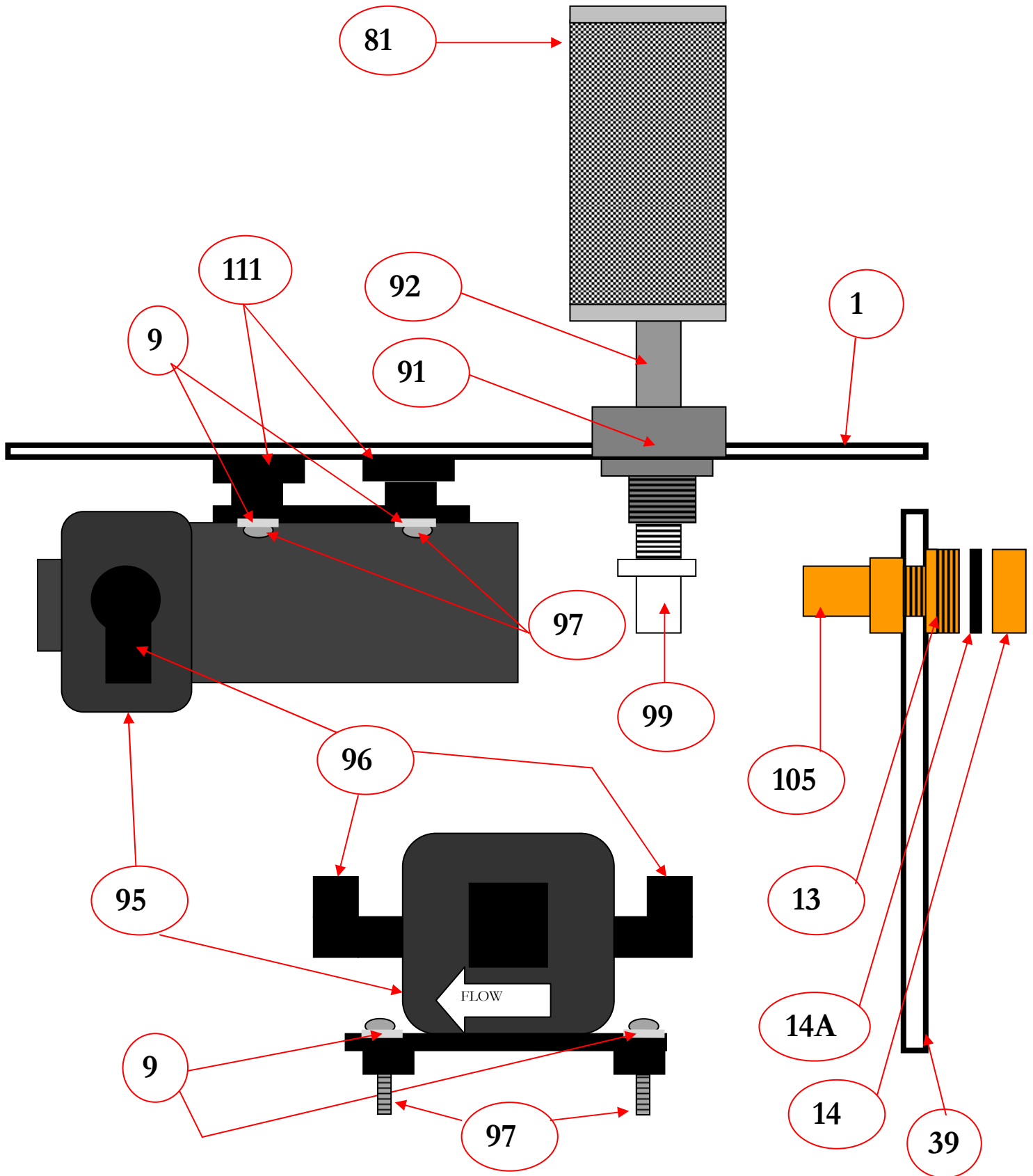

KEY	PART #	DESCRIPTION	KEY	PART #	DESCRIPTION

1	NM5704	RECOVERY TANK	22	BR174	ADAPTER ¼" M-F
2	NM5702	SOLUTION TANK	23	NM5751	WASHER ½" FLAT SS (Behind control panel)
3	PFA11	WASHER 5/16" FLAT SS	23A	NM5751A	WASHER ½" FLAT SS WITH NEOPRENE BACKING
4	NM5724	WHEEL 2-1/2" GRAY	24	NM5708	CONTROL PANEL PLATE
5	NM5143	ACORN NUT CAP 5/16-18	25	NM5708A	MX200 PANEL DECAL
NS	NM5137	SCREW 5/16-18 X 2.75" HX SS	26	NM5009	CORD 12GA W/ PLUG
6	NM5718	LID ASSY WASTE TANK	27	NM5038	CORD STRAIN RELIEF
7	PA187	SCREW #10 X 5/8" PH SS(QTY 6) (Attach lid to tank)	27A	NM5039	NUT CORD STRAIN RELIEF
NS	NM5718A	GASKET WASTE TANK DECK	28	PEA11	GATE VALVE 1-1/2" MPT
8	NM5028	SCREW ¼-20 X 1/2" SOCHD SS	29	NM5759	CORD WRAP BRACKET (QTY 2)
9	NM5066	WASHER ¼" FLAT SS	30	NM5014	WASHER ¼" LOCK SS
10	NM5840	WAND HOLDER STRAP LONG TOP STRAP	31	NM4063	SCREW ¼-20 X ¾" SOCHD SS
11	NM5844	WAND HOLDER BUCKLE	32	NM5722	WHEEL 12" with HUB CAP
12	NM5842	WAND HOLDER STRAP SHORT BOTTOM STRAP	NS	NM5010	AXLE CAP – PUSH NUT (Secure wheel to axle)
13	BR319	ADAPTER ¾" MPT X ¾" MGH	34	NM5754	COOLING FAN
14	BR325	GARDEN HOSE CAP	35	NM5757	PLASTIC FAN COVER
14A	BR600	GARDEN HOSE WASHER	36	NM5753	SCREW 6-32 X ¾" PPH SS(QTY 4)
NS	AH68	BARB 2" X 2" MPT PVC	36A	NM4031	NUT 6-32 NYLOCK SS (QTY 4)
15	AH224	FLASH CUFF 2" MALE - MPT	37	NM5710A	BASE PLATE ASSEMBLY Comes with Lift Handle & Hinges
NS	AH201	FLASH CUFF 2" FEMALE 1.5"	38	NA041	HANDLE
16	NM5716	ROCKER SWITCH DUAL SPST	39	NM5700	BASE SKIRT
17	NM5714	ROCKER SWITCH DPST	40	NM5750	HINGE (QTY 3)
18	NM5715	PANEL PLUG	41	NM5017	SCREW ¼-20 X ¾" HXHD SS
19		3/8" ID SOLUTION HOSE LP	41A	NM4261	NUT ¼-20 NYLOCK
20	NM5104	CIRCUIT BREAKER 3AMP	42	NM5947	SCREW 10-24 x ½" PPH SS(QTY 4)
21	AH101B	QUICK CONNECT FEMALE ¼"	42A	PHY094-034	NUT 10-24 NYLOCK SS(QTY 4)
<b>KEY</b>	<b>PART #</b>	<b>DESCRIPTION</b>	<b>KEY</b>	<b>PART #</b>	<b>DESCRIPTION</b>

43	NM5748	AXLE REAR WHEELS – 22.5”	68	NM5086	HOSE ½” ID CLEAR COIL
44	AP51	200PSI PUMP WITH MOTOR	69	NM5082	HOSE 3/8” ID CLEAR COIL
45	PT048	PRESSURE REGULATOR 200PSI	70	BR022	BARB 3/8” X 3/8” MPT
46	AV010	VACUUM MOTOR 2-STAGE	71		CAP 3/8” FPT HEX BRASS
47	NM5706	VACUUM MANIFOLD	72	NM5712	ADAPTER 2” FPT X SPG
47A	PA010A	VACUUM GASKET	73	NM5027	BRACKET SOL/REC TANK
48	NM5728	GATE VALVE 2” W/ KEEPER	74	NM5738	BRACKET TERMINAL BLOCKS
49	NM5728A	GASKET VACUUM VALVE	75	NM5730	TERMINAL BLOCK 6 SPACE
50	NM5139	SCREW ¼-20 X 2.25” SOCHD SS (QTY 6)	76	NM5732	TERMINAL BLOCK 10 SPACE
51	NM5726	VACUUM HOSE 2” – PER INCH	77	NM5142	SCREW #6 X ½” PPH SS (QTY 6)
52	PA051	HOSE CLAMP 2-2.75”	78	NM5756	FAN GUARD – WIRE FORMED
53	NM5705	DECAL VAC CONNECTION	79	NM4472	HOSE CLAMP W/THUMB SCREW
54	NM5133	SCREW ¼-20 X 2.00” SOCHD SS	80	NM5124	SCREW 8-32 X ½” PPH SS
55	NM5793	NUT 8-32 NYLOCK SS	81	NM5746	FILTER SS - ¾” FPT
56	NM5124	SCREW 8-32 X ½” PPH SS(QTY 6)	82	NM5098	BULKHEAD FITTING 3/8”
57	NM5752C	LATCH - SLIDE(QTY 2)	83	BR284	ELBOW 90DEG 3/8” STREET
58	NM5120	SCREW 5/16-18 X 3/4” HXHD SS	84	PP14-806504	ACORN STRAINER ¾” FPT
59	PFA10	NUT 5/16-18 NYLOCK SS	85	NM5727	ADAPTER 2”MPT X H PVC
60	NM5720	CASTER 5” (QTY 2)	86	PA029	PIPE 2” ABS (13.5”)
61	NM5752B	LATCH HOOK - KEEPER	87	NM5741E	CLAMP NYLON 2-2.5”
62	NM5752A	SPACER – LATCH HOOK	88	BR030	BARB ½” X 3/8” MPT
63	NM5128	SCREW 8-32 X ¾” PPH SS(QTY 4)	89	NM5713	ADAPTER 2”FPT X HSLIP ABS
64	NM4261	NUT ¼-20 NYLOCK SS	90	PH07	HOSE CLAMP
65	NM5721	SPACER BLOCK – PUMP MOUNT	91	NM5742	BULKHEAD FITTING ¾” PVC
66	NM5058	SCREW ¼-20 X 2.25” HXHD SS	92	NM5744	NIPPLE ¾” X 2” PVC
67	BR222	PLUG ¼” MPT HEX BRASS	93	NM5093	HOSE ¾” ID CLEAR COIL
<b>KEY</b>	<b>PART #</b>	<b>DESCRIPTION</b>	<b>KEY</b>	<b>PART #</b>	<b>DESCRIPTION</b>



94	PH09	HOSE CLAMP		NS	NM5025	RIVET – VAC HOSE END
95	AP37	PUMP-OUT PUMP		NS	NM5703A	WIRING HARNESS - UPPER
96	PF20381-010	ELBOW 90 3/4" BARB QUAD FTTG		NS	NM5701A	WIRING HARNESS - LOWER
97	NM5850	SCREW 10-24 X 1.25" PPH SS		NS	NM5711	DECAL NAUTILUS SIDE (QTY 2)
98	NM4255	WASHER #10 FLAT SS		NS	BR020	BARB 3/8" X 1/4" MPT
99	BR048P	BARB 3/4" X 3/4" MPT NYLON		NS	NM5758	KIT DUAL CIRCUIT WIRING
100	NA2250	HOSE CLAMP		NS	NM4087	SCREW 1/4-20 x 5/8" SOC BH SS
101	NM5735	FILTER CAP ASSEMBLY		NS	NM5434	#6 INTERNAL STAR WASHER SS CONTROL PANEL GROUND LUG
102	NM5741F	FLOAT VACUUM SHUTOFF		NS		SERIAL NUMBER PLATE WITH FOUR RIVETS
103	NM5725	GASKET VACUUM RISER PIPE		NS	NM5933	3/16" INT STAR WASHER SS FAN GROUND WIRE CONNECT
104		CAP 1/4" FPT HEX BRASS				
105	BR049	BARB 3/4" X 3/4" FPT				
106	PHY106-028	RUBBER VACUUM PLUG				
107	NM4263	SCREW TEK #10 X 5/8" SS				
108	NM4460	CABLE				
109	NM4462	SLEEVE #7 CABLE CLAMP				
110	NM5125	WASHER 1/2" FLAT ZINC PL				
111	NM4116	GROMMET 3/8"				
112	NM5737	MOISTURE BARRIER				
113	NM5433	1/4" INTERNAL STAR WASHER SS				
114	NM5705C	DECAL CSA WARNING				

<b>DESCRIPTION</b>	<b>HOSE TYPE</b>	<b>LENGTH</b>	<b>NOTES</b>
VAC HOSE REC TANK TO MANIFOLD	2" VAC – NM5726 SOLD PER FT	29"	TANK END: 1 - NM5713 2 – NM5025 VAC END: HOSE CLAMP PA051
VAC HOSE VAC 1 TO MANIFOLD	2" VAC – NM5726 SOLD PER FT	9.5"	VAC END: HOSE CLAMP PA051 MANIFOLD END: HOSE CLAMP NM4472
VAC HOSE VAC 2 TO BASE	2" VAC – NM5726 SOLD PER FT	9.5"	BOTH ENDS: HOSE CLAMP PA051
SOLUTION HOSE #1 SOLUTION TANK TO PUMP	1/2" ID CLEAR COIL NM5086 SOLD PER INCH	26"	BOTH ENDS: HOSE CLAMP PH07
SOLUTION HOSE #2 REGULATOR TO SOLUTION TANK	3/8" ID CLEAR COIL NM5082 SOLD PER INCH	20"	BOTH ENDS: HOSE CLAMP NA2250
SOLUTION HOSE #3 PUMP TO HP HOSE	3/8" ID LP HOSE NM4340 SOLD PER INCH	30"	BOTH ENDS: HOSE CLAMP NA2250
HP SOLUTION HOSE OUTLET QC TO HOSE #3	1/4" HP HYDROCOIL AH79CF SOLD PER FT	39"	QC END: XAF1 (M) * JOINT END: XAF2 (FM)
DRAIN HOSE REC TANK TO PUMP-OUT PUMP	3/4" CLEAR COIL NM5093 SOLD PER INCH	14"	BOTH ENDS: HOSE CLAMP PH09
DRAIN HOSE PUMP-OUT PUMP TO PUMP-OUT OUTLET FITTING	3/4" CLEAR COIL NM5093 SOLD PER INCH	13"	BOTH ENDS: HOSE CLAMP PH09

\* FITTINGS ADDED BETWEEN HOSE #4 AND CONTROL PANEL:  
(1) NM5751, (2) BR174 & (1) BR282

## Limited Warranty

Your Nautilus MX200 is designed to give you years of reliable service. If a problem should arise use the troubleshooting section in the operation manual to diagnose and correct the problem if possible.

If you are unable to determine the cause or solution to the problem contact your distributor or Hydro-Force for assistance.

Hydro-Force warrants the roto-molded tanks and base of the Nautilus MX200 to be free from defects in material or workmanship for five years from the date of purchase.

All other components of the Nautilus MX200 are warranted to be free of defects in material and workmanship for one year from the date of purchase.

During the warranty period, Hydro-Force will, at its option, repair or replace components which prove to be defective. This warranty does not provide for replacement of complete units due to defective components. Any costs for transportation or related service labor are not covered in this warranty. Replacement parts are warranted only for the remainder of the original warranty period.

This warranty shall not apply to defects resulting from improper operation, lack of maintenance, unauthorized modification, chemical incompatibility, misuse, abuse or exposure to freezing temperature conditions. It does not cover normal wear items such as o-rings, valve seals, pump seals, hoses, jets, cords, batteries, or other items which require replacement as a result of ordinary usage.

To obtain warranty service for the Nautilus MX200, contact your distributor or Hydro-Force. If the extractor must be returned to Hydro-Force or an authorized service center, the purchaser shall prepay shipping charges for products returned for warranty service. No returned items will be accepted by Hydro-Force without prior authorization. All returns must have a return authorization number, issued by Hydro-Force, clearly marked on the exterior of the package.

Hydro-Force makes no other warranty either expressed or implied with respect to this product.

The remedies provided herein are the purchaser's sole and exclusive remedies. In no event shall Hydro-Force be liable for any direct, indirect, special, incidental or consequential damages.

This warranty gives you specific legal rights. You may also have other rights which vary from jurisdiction to jurisdiction.